

The Genesis 10 Table of Nations and Y-Chromosomal DNA

[Richard P. Aschmann](#)

Table of Contents

1.	Two Family Trees Making the Same Claim.....	2
2.	First Obvious Difficulty: Different Origin Point and Tree Shape.....	2
3.	What the Table of Nations Tells Us	3
3.1.	Individuals or Nations?.....	3
3.2.	How Complete is the Table?.....	4
4.	Successful Matches between the Two Family Trees.....	4
4.1.	Shem	4
4.2.	Ham.....	4
4.3.	The Semitic Conundrum.....	5
4.4.	Japheth	8
4.5.	No Evidence for Racism!.....	9
5.	The Problem Posed by our Successful Matches.....	9
6.	A Possible Solution	10
6.1.	A Hamitic Conundrum?.....	10
6.2.	Implications of this Solution.....	11
6.2.1.	Shem.....	11
6.2.2.	Japheth.....	11
6.2.3.	Ham	12
7.	Are the Mutations Really “Reversible”?	12
7.1.	Initial feedback	13
8.	Broader Implications of this Solution.....	13
8.1.	Out of Babel Instead of Out of Africa	13
8.2.	Younger Dating for Mankind	14
9.	Tables and Maps.....	15
10.	About the Author.....	28
11.	Text of Genesis 10 (ESV).....	29
12.	Bibliography.....	29

Tables and Maps

Table 1: Language Distribution among the Descendants of Ham and Shem, Assuming the Simplest Scenario	7
Table 2: Table of Nations from Genesis 10.....	15
Table 3: Human Y-chromosome DNA (Y-DNA) Haplogroups	16
Map 1: Map of Nations from Genesis 10: Location Probabilities.....	17
Map 2: Section of Map 3 centered on Mesopotamia.....	17
Table 4: Some Haplogroup Names used on Maps 2 and 3 and Their Unambiguous Equivalents.....	18
Table 5: Tree of Haplogroup E subclades shown on maps 2 and 3	18
Map 3: World Map of Y-Chromosome Haplogroups	20
Map 4: Approximate Current Spread of Descendants of Shem, Ham, and Japheth throughout the World....	20
Map 5: Map of Semitic Languages in Ancient Times.....	21
Table 6: Leif A. Boström’s Rearrangement of the Y-Chromosome Tree	22
Table 7: Human Y-chromosome DNA (Y-DNA) Haplogroups Rearranged.....	23
Table 8: Detailed Analysis of Genesis 10, with Identities and Languages	24

1. Two Family Trees Making the Same Claim¹

If we study the Table of Nations in [Genesis chapter 10](#), and consider what light might be shed on it by modern genetic mapping of world migrations, or vice versa, we realize an important point: the Table of Nations in Genesis 10 (see [Table 2](#) and [Map 1](#)²) claims to show a family tree of the nations or ethnic groupings, based on descent through the male line only, which is precisely the same claim made for the family tree of Y-Chromosome Haplogroups (see [Table 3](#) and [Maps 2](#) and [3](#)), except of course that instead of nations they are genetic groupings called haplogroups. Those of us who believe strongly in the inerrancy of the Word of God believe that the facts laid out in Genesis 10 are true, so if the assumptions that underlie the Y-Chromosome Haplogroup tree are also valid, then we should be able to establish some sort of correspondence. Unfortunately, at first glance no such correspondence is apparent. Is such a correspondence even possible?

The structure of the two tables is somewhat different, the Table of Nations being a tree of fathers and sons (or ancestors and descendant peoples),³ causing it to widen out quickly, whereas the Haplogroup tree splits at mutations, making it much narrower. Even so, as I said above, since both tables make the same claim, then if both are based on valid assumptions, they should show some clear correlation.

2. First Obvious Difficulty: Different Origin Point and Tree Shape

If we look at [Map 1](#), we see that the descendants of the three sons of Noah seem to spread out from a point in the Middle East, presumably Babel (i.e. the city of Babylon⁴), since Genesis 11 suggests that most if not all people were situated there during that time.⁵ The descendants of Japheth went primarily north, those of Ham went primarily southwest,⁶ and those of Shem mainly stayed put in Mesopotamia or went southeast. All three sons clearly had numerous descendants, some of them clearly identifiable even today. Not all of the names in Genesis 10 can be identified or solidly located on the map, but at least those in red and dark red are fairly solid, making the three-way geographical split fairly clear. And again, the origin point is clearly the Middle East.

However, one thing that the Y-Chromosome Haplogroup tree, as normally presented, claims to have demonstrated is that [mankind originated in Africa](#), and experienced a significant amount of mutation before finally a carrier of the [CT \(or CDEF\) mutation M168](#), or possibly as late as [Haplogroup F \(F-M89\)](#), traveled [out of Africa](#). These migration patterns can be seen on [Map 3](#). “[Y-chromosomal Adam](#)” has recently been placed in West Africa, but [Dr. Fazale Rana has rebutted this](#), and suggested that an East African origin best fits the genetic evidence. This does not match the starting point suggested by Genesis 10, but it is close enough that it is not too problematic, according to Dr. Rana.

This still seems a bit of stretch to me: Babylon is a long way from East Africa.

¹ This article can be found on the Internet at: [Aschmann.net/BibleChronology/Genesis10.pdf](#). All substantive changes made to this article since it was first posted for the public, not including the addition of the numbered outline, can be found at: [Aschmann.net/BibleChronology/Genesis10-changes from 26-Dec-2014.pdf](#), with all changes marked in red and with a vertical line in the right margin, following the revision conventions of Microsoft Word.

² In several of the maps and charts, including [Table 1](#), [Table 2](#), and [Map 1](#), the descendants of [Shem are highlighted or outlined in yellow](#), those of [Ham in green](#), and those of [Japheth in orange](#), to allow for easier comparison.

³ See the discussion of this at the top of [Table 8](#).

⁴ The Hebrew term is בָּבֶל, *Bābel*. This clearly refers to the city of Babylon and is almost always translated Babylon in English Bibles, but in Genesis 11:9 it is usually translated Babel (and by many translations in Genesis 10:10 also), perhaps to show its similarity to the English word “babble”. The origin of its original [Akkadian form Babili, earlier Babilli or Babilla](#) is uncertain, but it seems to be related to the Hebrew verb בָּלַל, *bālal* “confuse”, as is suggested in Genesis 11:9. The English word Babylon is derived from the Greek Βαβυλών, itself from the Akkadian form.

⁵ It does not explicitly say that there could not have been a few who separated earlier, obeying God’s command in Genesis 1:28 and 9:1 and 7 to “Be fruitful and multiply and fill the earth”. However, since no mention is made of these exceptions of obedience after the pattern of Noah, it seems to me that the implication is that all participated.

⁶ For a discussion of Nimrod, see [Table 8](#).

Also, the first split of the table is not three-way, but only two-way, and the table continues to make mainly two-way splits as it goes along. Now this is not fundamentally important, since the splits in the table are based on mutations, which can occur randomly at any point in a genealogical table. However, since Genesis 10 makes it clear that all three of Noah's sons had numerous descendants, it would seem to require that the first mutation occurred even before the Flood, in one of Noah's sons, but not in the other two.

However, as we begin actually trying to identify some of Noah's descendants, and try to match them to current populations, we find that it's not that simple, in fact we find that we have a serious problem in matching up the two tables.

3. What the Table of Nations Tells Us

But before we look into it, we need to look again at what the Table of Nations in [Genesis 10](#) is telling us.

Sometimes the names in the Table of Nations can be identified with a particular location or region, shown by many of the names in red on [Map 1](#), and in some cases we can identify a particular ethnic/language group by name in this table, such as Javan (the Ionian Greeks), Madai (the Medes), Aram (the Arameans), Elam (the Elamites), Canaan (the Canaanites), or Mizraim (the Egyptians), each of whom had their own identifiable language. Some of these stayed in the same place through most of recorded history, speaking essentially the same language,⁷ like the Egyptians, though their original language ([Coptic](#)) died out as a spoken language in the 17th century, being replaced by Arabic, though it survives as the liturgical language of the [Coptic Church](#).

In other cases, as in the names in light gray on [Map 1](#), we have very little or no information either about where they lived or about what language they spoke. And those in dark red and charcoal fall somewhere in-between.

3.1. Individuals or Nations?

But aren't some of the names in the table individuals rather than nations? And shouldn't the non-terminal names in [Table 2](#) be assumed to be part of a genealogy of individuals, including at least the third column, Noah's "grandsons"? Not necessarily, as I explain in the introduction to [Table 8](#): most of the known names seem to refer to nations or ethnic groups, so may not refer to individuals at all.

However, to answer the first question, yes, certainly some of the names in the table are individuals. Noah is certainly an individual, as seen all the way through Genesis 6-9. And Shem, Ham, and Japheth are clearly individuals, and are clearly the first generation sons of Noah, because they were among the 8 people who lived on the ark for a year, along with each of their wives, and acted individually and distinctly in the story of Noah's drunkenness in Genesis 9:18-28. Canaan, on the other hand, even though he is mentioned repeatedly in the latter passage, and even though he is specifically cursed because of Ham's actions, never actually appears as an individual actor in the story, so the curse could just as easily be upon a nation rather than an individual. Granted, he may also have been the individual who founded the ethnic group that eventually became the Canaanites, but the table cannot be used to prove this one way or the other.

In fact, beyond Shem, Ham, and Japheth themselves, no single name in the table comes into focus as an individual actor except for Nimrod, and his case is unique, as I explain in [Table 8](#).⁸ (Even so, it seems clear that Abram's ancestors from Arpachshad down to Peleg are individuals, since they are also listed in Abram's genealogy in Genesis 11, which seems to be a list of individuals from start to finish; also, though

⁷ However, these have all changed greatly through time. See my article [God Doesn't Have Favorite Languages](#) for a detailed explanation of this.

⁸ [Keil and Delitzsch](#) contend that Sidon in verse 19 must also be an individual, mainly because he is called Canaan's "firstborn", though even here the NIV footnote suggests another interpretation: "Canaan was the father of the Sidonians, the foremost", which would be an accurate description. By tradition it was also the oldest city in Phoenicia, according to Wiseman in the *New Bible Dictionary*, which could also be the meaning. A second reason they give is that, though 9 out of the 11 "descendants" of Canaan are expressed as national or ethnic groups ending in "-ite(s)", Sidon and Heth are listed as if they were individuals. However, as I discuss in the following paragraphs, this does not prove that they were, since some such names almost certainly were not.

Elam, Asshur, Lud, and Aram all seem to be the names of known nations or cities, as do many of the other “descendants” of Shem, Arpachshad does not.)

This all suggests that, unless we have evidence to the contrary, most of the names in the table should be assumed to be nations or ethnic groups rather than individuals. (This does not preclude the possibility that in some cases an individual was indeed the founder of a nation, which took his name, but in at least a few cases this is not likely, as in the case of the mixed nations of Sheba and Havilah. In any case, for convenience I will often treat them as individuals, referring to “the descendants of Aram”, without resolving the question.) This implies that the columns in [Table 2](#) should not be assumed to be generations at all, but simply lines of descent.

Even so, the argument of this article still holds true, that the table demonstrates descent from Shem, Ham, and Japheth through the male line, since only the male line counted in the ancient world, and in biblical genealogies.

3.2. How Complete is the Table?

Should the table be assumed to be complete in the sense of covering the whole world’s ethnic groups at the time it was made? Evidently not: all of the nations that can be identified are geographically close to the nation of Israel, and for most we have at least fairly good evidence of their location. This suggests that the intent of the table was only to show the descent of those nations that were generally familiar to the peoples of the Middle East. Moses evidently wrote Genesis during the Israelites’ sojourn in the wilderness in the 15th century B.C. (see [Aschmann.net/Bible Chronology](#)). There is no question that at that time every continent except Antarctica was already well populated by humans, but there seems to be no attempt in the table to include any but the nearby nations.

In §6.1 we shall deal with this question again.

4. Successful Matches between the Two Family Trees

If we compare [Map 1](#) with [Map 2](#) (which is one section of [Map 3](#)), when we attempt to match some of the people groups on [Map 1](#) with those on [Map 2](#), we find that we can do so with some certainty for a few of them, especially for the descendants of Shem and Ham, though tentatively also with Japheth. In particular, we find that for each of Noah’s sons there is at least one Y-chromosome haplogroup that we can fairly reliably associate with some of their descendants, even though nearly all of the other haplogroups cannot be so associated. (For all of the discussion that follows, please consult the haplogroups listed in [Table 4](#) below as we go along.)

4.1. Shem

For Shem we have a huge clue, and that is that science has established that [haplogroup J-P58](#), also known as the Cohen Modal haplotype, is evidently the haplogroup of Aaron, the ancestor of the Jewish priestly line. This haplogroup is a descendant of [Haplogroup J-M267 \(J1\)](#), which from [Map 2](#) we can see is primarily found in the southern part of the Middle East, precisely the area that was populated by Abraham and his relatives and descendants. We can also see that its sister [haplogroup J-M172 \(J2\)](#) is found primarily in Mesopotamia, the other major area populated by descendants of Shem, as seen in [Map 1](#). Thus, I would say that we can affirm with some confidence that [Haplogroup J \(J-P209\)](#), the parent of these two groups, is undoubtedly descended from Shem.

4.2. Ham

If we look at [Map 1](#), we immediately see that Ham is largely confined to Africa, except for a few places where it spills over into Asia, notably the eastern end of the Mediterranean and parts of western Arabia, and one Mediterranean island, Crete. On the other hand, neither Shem nor Japheth has any presence in Africa, except for the very tentative Ophir. If we then look at Africa on [Map 3](#), one haplogroup immediately jumps out at us as occupying most of Africa, and very little outside Africa: [haplogroup E \(E-M96\)](#). And we

observe an interesting thing about this haplogroup: it corresponds very closely to two of the world's most important language families: The [Afro-Asiatic language family](#), spoken mainly in North Africa and the Middle East, and the [Niger-Congo language family](#), spoken in much of Sub-Saharan Africa, though it apparently originated in Sub-Saharan west Africa, and probably only began occupying southern Africa around 1000 B.C. with the [Bantu expansion](#), displacing many older populations there, of whom remnants still remain across the area. If we compare a map showing the [language families of Africa](#) with [Map 3](#), we see how consistent this correspondence is, with only a few exceptions. In fact, these language families were listed on [Map 3](#) because its creator was well aware of these correspondences.

It is not possible to identify any of the speakers of the [Niger-Congo languages](#) with any of the peoples of Genesis 10, but it turns out that quite a few of the peoples who speak, or have historically spoken, [Afro-Asiatic languages](#) can be clearly identified with descendants of Ham, among them the Egyptians (speaking the [Egyptian language](#), whose modern descendant is Coptic); the [kingdom of Cush](#), whose written language, [Meroitic](#), though undeciphered, shows evidence of being Afro-Asiatic, and in fact probably belonged to the [Cushitic](#) subfamily of Afro-Asiatic languages, still spoken widely in the same area, and as far south as Somalia and Kenya; and even Put (or Phut), which Josephus and other ancient sources associated with [Ancient Libya](#), which spoke languages in the [Berber](#) subfamily of Afro-Asiatic, still widely spoken in north Africa.

I would submit that this provides sufficient evidence that the carriers of [haplogroup E \(E-M96\)](#) are clearly descended from Ham, which would include the speakers of the [Niger-Congo languages](#) and the speakers of most of the subfamilies of [Afro-Asiatic languages](#).

4.3. The Semitic Conundrum

However, of the six subfamilies of the [Afro-Asiatic languages](#), one of them presents us with a conundrum, the [Semitic languages](#),⁹ a conundrum not just for Genesis 10, but for genetic studies in general. And this is because the speakers of the Semitic subfamily of Afro-Asiatic are consistently and overwhelmingly descended not from haplogroup E (E-M96), but from [Haplogroup J \(J-P209\)](#) that we have discussed above, and are mainly descendants of Shem as described in Genesis 10. This includes Aram, whose descendants spoke [Aramaic](#) (still spoken today), and Asshur, whose descendants spoke the ancient Assyro-Babylonian language called [Akkadian](#) (now extinct). Some of the descendants of Arpachshad, specifically the descendants through Joktan, seem to have moved south into the Arabian Peninsula and formed their own subgroup of Semitic, the [South Semitic languages](#) (with descendant languages still spoken today),¹⁰ as we shall see in [Table 8](#). The other descendants of Arpachshad, through Peleg, seem to have spoken the Aramaic language along with the descendants of Aram. Abraham's family was in this group, and spoke Aramaic, but subsequently adopted the Canaanite language after they moved to Canaan, and this then developed into the Hebrew language. Abraham's relatives that remained in Haran never spoke Hebrew.¹¹

However, of course it couldn't be as simple as that all of the descendants of Shem spoke Semitic languages: the Elamites, descendants of Elam, spoke a language, [Elamite](#), that was written for many centuries, and is well understood, but which does not seem to be related to any other language; it is now extinct. As for Lud, we do not know for certain who his descendants were or what language they spoke.

To complicate matters even more, the descendants of one of Ham's sons, Canaan, spoke a Semitic language, Canaanite, with many similarities to Aramaic, though clearly a different language from its earliest history. The Israelites, a Semitic people, adopted this language and developed it into Hebrew, after which

⁹ See [Map 5](#) to see the locations of the Semitic languages in ancient times with some of the Biblical connections mentioned in this section.

¹⁰ The Semitic languages of Ethiopia and Eritrea, which are also in the South Semitic subfamily, and the corresponding strong presence of [Haplogroup J-M267 \(J1\)](#), suggest that the speakers of these languages also are descendants of Joktan, and their traditions largely confirm this, claiming a connection to Sheba. However, the only name in Shem's table that is normally placed in Africa is Ophir. Whether these correspond or not is unclear.

¹¹ This is explained in excruciating technical detail in the Appendix at the end of my article [When Was Hebrew First Written?](#) Additional (non-technical) information can be found in [God Doesn't Have Favorite Languages](#).

most of the Canaanites were either wiped out by the Israelites or were absorbed into later cultures. Quite a convoluted story, isn't it?¹²

So what happened here? Going back to the [Afro-Asiatic languages](#), this is probably the [oldest language family](#) that it has been possible to reconstruct using the [comparative method](#),¹³ perhaps some 12,000 years old ([estimates](#) range from 9,500 to 18,000 years old). In other words, around 10,000 B.C. there was a single language, which linguists call the [Proto-Afro-Asiatic language](#), which gradually changed through the years as its speakers spread out and moved around, until it diversified into all of the highly divergent languages in the family today.

So, were the speakers of that original Proto-Afro-Asiatic language descendants of Ham or descendants of Shem? We do not know, but it seems probable that they were descendants of Ham, given that five of the six subfamilies are African and Hamitic. Where did they live? We have no idea, but again probably somewhere in northeast Africa. Why did some (but not all) of the Semitic peoples adopt the language of a separate ethnic group without merging with that group, as is evidenced by the fact that their form of Afro-Asiatic later diverged from the others? And how is it that the Canaanites, a Hamitic group, ended up speaking the variety used by the Semites? We don't know, but many times throughout history a people has abandoned its own language because of conquest or intermarriage or even just for commercial or prestige reasons.¹⁴ We really know very little about the history of these peoples and their languages before the first Afro-Asiatic language, Egyptian, was first written down using [Egyptian hieroglyphics](#) around 2700 B.C., except what we can learn by comparing their languages and studying their geographic distribution, and that information is obviously limited. Occasionally archeology can provide some clues also, but assigning archeological remains to language groups is very uncertain.

The simplest scenario might be that the language borrowing didn't occur twice but only once: that the Hamitic Canaanites' variety of Afro-Asiatic diverged from the others over time, as they moved from Africa into southwest Asia,¹⁵ and then for unknown reasons a large portion of the Semites, including the descendants of Asshur, Arpachshad, and Aram (but not Elam,¹⁶ and probably not Lud) adopted this language, after which the Semitic forms and Canaanite diverged from each other over more time.¹⁷ This seems to be the simplest solution according to [Occam's razor](#), requiring only one case of a people abandoning their language instead of two. (I have laid out the details of this idea in [Table 1](#).)

¹² Actually several other Hamitic groups evidently also spoke Semitic languages, including all of those Hamitic groups shown on [Map 1](#) who settled in the Arabian Peninsula, all of which were descendants of Cush, notably Dedan and Havilah, but less is known about these, so my argument will focus on Canaan. These will all be discussed below.

¹³ However, the recently reconstructed [Dené-Yeniseian language family](#) may have a similar age. It is composed of two groups of languages that would have remained largely isolated throughout their history, which would have reduced the amount of language change occurring, facilitating the reconstruction.

¹⁴ One pertinent example of this is Abraham's family, who abandoned their native Aramaic and adopted the Canaanite language, for the simple reason that they now lived in Canaan, even though by God's grace they were able to avoid being absorbed into Canaanite culture.

¹⁵ Whether Dedan and Havilah's descendants, mentioned in footnote 12, accompanied Canaan's descendants, or were a later migration, is unknown, but this does not affect my scenario. The other Hamitic groups that settled in the Arabian Peninsula were probably later migrations, as we will see below.

¹⁶ Since we are speculating, this might suggest that the previous language of the Semitic people was the ancestral form of the [Elamite](#) language mentioned above, though of course the descendants of the various sons of Shem might not even have been given the same language at the Tower of Babel.

¹⁷ This divergence would have begun perhaps about [3750 B.C.](#), a reasonable estimate for the date of Proto-Semitic (which, [assuming this scenario](#), we [should](#) now call [something else, like Ancestral Canaanite](#)), because by 2800 B.C., when [the first Akkadian proper names were attested in Sumerian texts](#), Akkadian had already diverged from the rest to form the eastern subfamily.

Table 1: Language Distribution among the Descendants of Ham and Shem, Assuming the Simplest Scenario

Ham ↓ Proto-Afro-Asiatic language	Put	→	<u>Berber</u>		
	?	→	<u>Chadic</u>		
	Mizraim	→	<u>Egyptian</u>		
		?	→	<u>OmotiC</u>	
	Cush	→	<u>Cushitic</u>		
		→	Havilah →	→ <u>Arabic languages</u> ^a	<u>Arabic</u>
		→	Dedan →	→	<u>A.N.Arabian</u>
	descendants		<u>"Semitic"</u>		<u>Phoenician</u>
	Canaan move to Asia	→	(<u>Ancestral-Canaanite</u>)	<u>Canaanite</u>	<u>Canaanite</u>
				<u>North-languages</u>	
			<u>Central west</u>	adopts Canaanite ↑ moves to Canaan, ↑ Abraham's family Nahor's family remains in Haran	
Shem ↓ Proto-Elamite language?	Aram	descendants	→ <u>Semitic</u> <u>Semitic</u>		
	Arpachshad	→ of three sons of	┌ Peleg → <u>Aramaic</u>		
		→	└ Joktan ^c → <u>South Semitic</u>		
	Asshur	"Semitic"	→ <u>East Semitic</u>		
	Elam	→	<u>Elamite</u>		
	Lud	→	?		

In the table above and in the text and notes below, **bold face** and **thick colored lines** indicate people groups or family lines and the Arial font and **thin black lines** indicate languages and language families and subfamilies. **Dotted red lines** indicate people groups who have adopted a language different from that of their forefathers.

Four of the subfamilies of Afro-Asiatic can with some certainty be assigned to the four sons of **Ham**, leaving two unassigned. Given their geographic locations, it is possible that **Chadic** also descended with **Berber** from **Put**, and **OmotiC** with **Cushitic** from **Cush**, though we cannot be certain. And of course we have no information at all about which son(s) the **Niger-Congo** family might have descended from, or exactly what God might have done at the Tower of Babel to bring about the current distribution.

I have not included either the **Ugaritic** or **Amorite** languages in the above chart. Ugaritic was closest to the **Canaanite** languages, though it had several very conservative features. The scantily known Old Amorite, whose **speakers** are mentioned as early as 2400 B.C. in middle eastern sources, and who occupied large parts of Mesopotamia over several centuries, was also very conservative but closest to the **Canaanite** languages. In its later history it was apparently simply a dialect of **Canaanite**, though **few or no texts** seem to have been written by any **Amorites** at any stage.

I have also not indicated the **Niger-Congo languages** in the above chart, even though their speakers are probably also descended from **Ham**.^d

^a Some sources, including the **Ethnologue**, group Arabic with the **Canaanite** languages in a **South-Central Semitic** group. However, the **Arabic languages** have some very conservative and distinctive features, and could not have directly descended from **Canaanite** or **Hebrew**, but must have had a distinct source farther south.

As the chart shows, this subfamily split into two subgroups, **Arabic** proper and **Ancient North Arabian**.

As to who the speakers of the **Arabic languages** descended from, this is not at all clear, and seems to have been a mixed bag. For example, of the various **subgroups who spoke Ancient North Arabian**, only three can be associated with biblical tribes: **Dedan**, **Dumah**, and **Tema**. **Dedan** is clearly descended from **Cush**, whereas the other two are sons of **Ishmael** mentioned in Genesis 25:14. Descendants of all three of these are associated with oases northwest of **Havilah** on **Map 5** (see links for

[Dadanitic](#), [Dumaitic](#), and [Taymanitic](#) at the Ancient North Arabian subgroups link above). However, for the purposes of [Map 1](#) **Dumah** and **Tema** really don't count, since they would have arrived many millennia later than **Dedan**. (Similarly, Genesis 25:2 suggests that some descendants of Abraham's son Jokshan may also have become major contributors to the Dedan community, though this would again have been many millennia later.)

As for **Arabic** proper, its homeland was farther south, as shown on [Map 5](#), and although Arab tradition connects them with **Ishmael**, and Genesis 25:18 indicates that **Ishmael**'s descendants did settle in this area as well, "from Havilah to Shur" (Shur is in the Sinai), the language itself shows signs of being significantly older, so again the Ishmaelites would have been latecomers. If we have located **Havilah** correctly, then **Havilah** would be the best choice for **Arabic**. **Havilah** was probably a mixed group, made up of descendants of both **Ham** and **Shem**, as discussed in [Table 8](#).

^b See footnote 16.

^c Nearly all of the descendants of **Joktan** probably spoke South Semitic languages (see [Table 8](#) and [Map 5](#)), but based on its location **Havilah** probably spoke an early form of **Arabic** proper, and was in any case a merged group, as discussed in footnote a.

Those descendants of **Ham** through **Cush** that settled in the Arabian Peninsula other than **Dedan** and **Havilah** settled in the south of the peninsula and presumably adopted South Semitic languages from **Joktan**'s descendants. One case, **Sheba**, was apparently a merged group made up of descendants of both **Ham** and **Shem**, as discussed in [Table 8](#).

^d If both the Afro-Asiatic languages and the Niger-Congo languages are spoken by descendants of Ham, the question arises as to whether the two language families might not both be descended from the same proto-language. However, for two reasons there is no way to establish this.

First of all, the [comparative method](#) has a [natural limitation of about 10,000 years](#), after which we run out of sufficient data for comparison. This is because the number of words that match at each stage in the reconstruction of subfamilies diminishes at each stage through vocabulary change, until the corpus is so small as not to be distinguishable from random similarities. The Afro-Asiatic family is an exception in that it has been possible to reconstruct somewhat beyond this limit, but this is largely because two of the subfamilies (Egyptian and Semitic) have some of the oldest traditions of writing in the world, Egyptian starting at around 2700 B.C., and the appearance of [Akkadian proper names in Sumerian texts](#) beginning at around 2800 B.C., with native texts from around 2500 B.C., giving us a head start of nearly 5,000 years in two separate subfamilies. A third subfamily, the [Berber languages](#), has been written since around 200 B.C., allowing some triangulation from that point. So the reconstruction of Afro-Asiatic is already at the limit of what can be established through [comparative linguistics](#), making it impossible to determine its relationship to Niger-Congo.

Secondly, it is quite possible that these two language families were divided by God at the tower of Babel, with some Hamitic clans speaking Proto-Afro-Asiatic and some Proto-Niger-Congo, and some possibly other languages as well, in which case they would presumably *not* be related to each other.

Whatever the historical details were, there is no doubt that some such scenario did occur: both secular genetic studies and Genesis 10 agree in confirming that the speakers of the Afro-Asiatic languages have two distinct genetic origins, one Hamitic, corresponding to [haplogroup E \(E-M96\)](#), and one Semitic, corresponding to [Haplogroup J \(J-P209\)](#).¹⁸

4.4. Japheth

Several of the descendants of Japheth can be associated with a location, e.g. Dodanim, Madai, Tarshish, but very few are identifiable with an ethnic or linguistic group, some of the few that are being Javan (the Ionian Greeks)¹⁹ and Madai (the Medes), with less certainty Gomer (the Cimmerians), with even less certainty Ashkenaz (the Scythians), and as a wild guess Tiras (the Thracians). We might say, "Wow, that's excellent, all of those people spoke [Indo-European languages](#). Japheth must be the father of the Indo-Europeans!" And that is probably true, though because of the volatile history of these areas, the genetic situation has become somewhat obscured. It is certainly true that [Haplogroup R-M420 \(R1a\)](#) is almost certainly the haplogroup of the original Indo-Europeans (see [Table 4](#)), and it can be seen on [Maps 2](#) and [3](#) that this haplogroup dominates several large areas of Eurasia, in particular one near the probable home area of Indo-European north of the Black Sea, which is also where the Cimmerians and the Scythians lived. It also dominates an area from eastern Persia to northern India, not far from the home area of the Medes. But haplogroups [E \(E-M96\)](#) and [J \(J-P209\)](#) seem to have moved in to obscure the correspondence for much of this

¹⁸ This dual ethnic origin of the family was evident long before the advent of modern DNA studies: the original name for the Afro-Asiatic language family was the [Hamito-Semitic family](#), recognizing that its speakers were descended from these two sons of Noah.

¹⁹ His listed descendants were also located in the Ionian area and presumably spoke Greek, except for Tarshish.

area.²⁰ And in any case the Indo-European family is much younger than Afro-Asiatic, dating from perhaps 3,500 B.C., so that they would have had much less impact on the genetic situation.

Even so, we can probably safely posit that, among others, haplogroup R indicates descent from Japheth. We really cannot identify any other likely haplogroups for Japheth at this point.

4.5. No Evidence for Racism!

Before proceeding, I need to clarify that one historical assumption that has been made about Genesis 10 is not true:

There is no truth to the idea that any of the three sons of Noah is to be identified with a particular race of humanity; in particular, it is not true that the black race came from Ham, nor that the [Aryan](#) race came from Japheth.²¹ If there is any valid meaning to the term “race”, a controversial question, it correlates to genes throughout the human genome,²² and cannot be correlated to the Y-chromosome or strict male descent.

5. The Problem Posed by our Successful Matches

Thus we can associate with some confidence precisely one major Y-chromosome haplogroup with each of Noah’s three sons, E for Ham, J for Shem, and R for Japheth. However, if we then look at [Table 3](#) to see how this will help us interpret the Y-chromosome tree, we find that it does not really help at all!

²⁰ Or alternatively, the Indo-Europeans, including the Greeks and the [Anatolian languages](#), when they moved into the area from the north, imposed their languages as conquerors or at least the prestige population without displacing the original inhabitants, so that their Y-DNA never became the majority. Such a scenario is quite common, and seems to be what happened when Indo-European spread to western and southern Europe as well, where the principal haplogroups are I and R1b, not R1a, as can be seen on [Maps 2 and 3](#), even though nearly all of Europe now speaks Indo-European languages.

²¹ The only valid meaning of the term [Aryan](#) is to refer to the speakers of the [Indo-Aryan languages](#), or more broadly the [Indo-Iranian languages](#), who historically used the term to refer to themselves. These people speak Indo-European languages, and many of them probably do descend from Japheth, but the term never referred to the Indo-European-speaking peoples as a whole, much less the “white race”, and the whole concept of an “Aryan race” is based on a number of false ideas.

²² Many now claim that racial definitions have no meaning at all, but Rosenberg, et al ([ncbi.nlm.nih.gov/pmc/articles/PMC1310579/](#)), have demonstrated that there is some meaning to racial categorizations, but only as averages across a population, not as distinct categories of humanity. Their fascinating chart can be seen at: [ncbi.nlm.nih.gov/pmc/articles/PMC1310579/figure/pgen-0010070-g002](#). A later chart with 7 categories can be found at: [meta.anarchopedia.org/images/thumb/f/f9/Rosenberg2007.png/150px-Rosenberg2007.png](#), cited in [rosenberglab.stanford.edu/papers/india.pdf](#) (page 2055, though there the chart is sideways and is hard to read).

What they show is that mankind can be divided into any number N of geographic clusters using objective genetic criteria. The studies show which clusters result when N is 2, 3, 4, 5, 6, or 7.

However, they are quick to distance themselves from any charge of traditional “racism”:

Our evidence for clustering should not be taken as evidence of our support of any particular concept of “biological race.”... The arguments about the existence or nonexistence of “biological races” in the absence of a specific context are largely orthogonal to the question of scientific utility...

In spite of this disclaimer, the interesting thing about these studies is that they demonstrate that, simply using computer-generated genetic clustering, if humanity is divided into three clusters, what appear are the three main traditional categories of human ancestry, traditionally called “Caucasoid” (or “Caucasian”) (Europe, North Africa, and Southwest and South-Central Asia), “Mongoloid” (East Asia and Native America), and “Negroid” (Sub-Saharan Africa). (Rosenberg, et al, never use these traditional terms in their study, only using the geographic terms in parentheses.)

Such categorizations are also still found to be valid in [forensic anthropology](#), where the traditional terms are still commonly used. However, these three terms are now avoided in many contexts, and are even considered offensive by many, the preference being to say “European” instead of “Caucasoid”, “Asian” instead of “Mongoloid”, and “African” instead of “Negroid”. However, since their geographic boundaries do not actually correspond to continental boundaries, such continental terms are necessarily imprecise, and the more accurate geographic terms shown in parentheses in the preceding paragraph are too long to be practical, leaving us with no handy terms to use that do not offend someone! (As Rosenberg, et al, observe, the most important boundaries turn out to be the Sahara Desert and the Himalayas.)

It turns out that one of the most commonly cited physical characteristics, skin color, is [not found to correspond well](#) to these three divisions. For example, the population of India is overwhelmingly Caucasian, though the full range of skin colors is found there. In any case, such categories do not provide any support for any of the abuses historically perpetrated in the name of race.

Instead, we find that haplogroup E is found as a side branch of a side branch fairly high in the tree, haplogroup J is found as a side branch of a side branch a bit past the middle of the tree, and haplogroup R is found nearly at the bottom of the tree. This makes it impossible to find any way to assign the branches to the three sons of Noah, something which, as we saw above, should be possible, if God’s Word is inerrant, and if the science behind the Y-chromosome tree is good science. And these are two assumptions that I am unwilling to give up!

Actually, I would be willing to give up the second far more easily than the first. But supposing that the details of the science behind the Y-chromosome tree are fine, but that some of the underlying assumptions determining the shape of the tree are not? Supposing that one of those assumptions, the theory of evolution, which I reject as unscientific, has determined the starting point for the tree when that starting point would not necessarily be clear otherwise?

6. A Possible Solution

Over quite a long time I tried to make sense of the evident discrepancy of the Y-chromosome tree with Genesis 10, but it was only when I stumbled on an article by a Swedish young-earth creationist named Leif A. Boström that I thought, “This is ingenious! Could it be the solution?”

At this point I will draw your attention to [Table 6](#), the tree drawn by Leif A. Boström and found in his article cited above the table, and to [Table 7](#), my rearrangement of [Table 3](#) to follow his idea. As I said, Boström is a young-earth creationist (which I am not, though I am certainly a creationist who rejects evolution),²³ but he has assumed (as I have) that the basic science behind the Y-chromosome tree is valid. However, the key point is that he suggests that the directionality of many of the mutations is actually reversed, in fact that they are reversed for almost half the table.

And this solves our problem very nicely: he assumes that Noah’s genetics are represented not by the parent of haplogroup A, but by [haplogroup IJK](#). This very conveniently puts all of Shem under [Haplogroup IJ](#), all of Japheth under [Haplogroup K \(K-M9\)](#), and all of Ham under [Haplogroup HIJK](#),²⁴ but with all of the mutations reversed from A to IJK, at least for the main backbone of the tree.

And of course, it puts our three identifiable haplogroups E, J, and R under the right son of Noah! Boström identified these three just as I did, saying “the most probable haplogroup for Japheth would be R1, Shem J and Ham E1b1b”, though he does not explain the reasoning process that leads him to this conclusion.²⁵

6.1. A Hamitic Conundrum?

However, it now might seem that our success in restructuring the haplogroup table actually produces a conundrum precisely in the part of the Hamitic table that we seem to have identified so thoroughly: Haplogroup E! The problem is this: in §4.2 and §4.3 we were able to assign all four of the “sons” of Ham to at least one subfamily of Afro-Asiatic, all of which are identified with sections of Haplogroup E. However, this leaves no opportunity for all of the other branching that occurs in the new Hamitic tree, since Haplogroup E

²³ I adhere to the [Reasons to Believe](#) model of humanity’s origins, which rejects [macroevolutionary](#) assumptions and maintains that Adam and Eve were created by God and were the ancestors of all humanity. It rejects any descent of humans from apes or even from other hominids like the Neanderthals. Just a few of many articles on this subject are: [reasons.org/articles/the-leap-to-two-feet-the-sudden-appearance-of-bipedalism](#), [reasons.org/blogs/take-two/of-hominids-and-humans](#), [reasons.org/rtb-101/historicaladam](#), [reasons.org/articles/from-whence-do-we-come-part-1-of-2](#).

It is interesting that the issue I am dealing with in this article is somewhat independent of one’s position on the age of the earth, but focuses specifically on a limited field of science. Even so, it is hard to see how to fit the vast number of mutations into the short time frame of a young earth, and Boström seems to show that he is aware of this in his “COMMENTS IN NOVEMBER 2014” at the end of his article.

²⁴ This haplogroup is now properly defined as being distinct from haplogroups [F \(F-M89\)](#), [G](#), [H](#), and [GHIJK](#) in the latest version of the [en.wikipedia.org/wiki/Human_Y-chromosome_DNA_haplogroup](#) table (as of November 3, 2016), though earlier it was not.

²⁵ In earlier versions of this article (before August 10, 2015) I had said, “...apparently Boström identified these three just as I did, though he does not say so”, which was unintentionally misleading. He himself pointed this out to me, so I have amended it to be accurate.

is simply one side branch of the tree, several steps down from Ham himself. Logically Haplogroup E should have descended from only one of Ham's sons. Are any of our four identifications uncertain? No, the identification of all four is quite solid!

However, as we saw in §3 and its subsections, the Table of Nations was evidently not intended to cover all the nations of the earth that existed at the time it was written, only those that were nearby and known to the people of Israel. It is also not necessary to assume that the Hamitic names in the third column of [Table 2](#) are actually Ham's sons, but simply the descendant nations of Ham (or their eponymous founders) that were nearby and known to the Israelites. And if the theory presented in this article is valid, this would require that these four nations, as well as the speakers of the [Niger-Congo languages](#), all descended from a single (unnamed) descendant of Ham, the founder of Haplogroup E! Thus all of the branching between Ham and Haplogroup E would not have been included in the table, and in fact many more nations descended from Ham than just these four, as we shall see below. So our apparent conundrum is resolvable.

The same sort of argument would apply to Japheth: the only descendants of Japheth mentioned in Genesis 10 are those that were nearby and known to the Israelites, many of whom spoke Indo-European languages and would thus represent Haplogroup R, but not the other branches of our revised haplogroup table. Thus, the "sons" of Japheth listed would not actually have been his sons but simply one later branch of descent.

Shem, however, is a different story. Most of his descendants remained in the Middle East, and were thus more thoroughly covered, as we shall see in §6.2.1 below, so it is more likely that the "sons" of Shem listed actually were his sons, or at least that they cover all or nearly all of his descendants.

6.2. Implications of this Solution

And as Boström lays out the implications of this revised tree in the rest of the article (and as I see additional implications), it seems to make sense, or at least does not contradict any of the information in Genesis 10 or the rest of the Scriptures.²⁶

6.2.1. Shem

Haplogroup I (see [Maps 2, 3, and 4](#)) presumably then represents the descendants of Lud son of Shem, who moved on into Europe and much later would have adopted Indo-European languages, whereas the rest of the descendants of Shem, who as we have seen are all pretty well identified, are part of [Haplogroup J \(J-P209\)](#) and remain in the Middle East.

6.2.2. Japheth

Under this structure most of Japheth's descendants, represented by haplogroups K through X on [Map 3](#) and [Map 4](#), end up in Europe, Asia, the Americas, and the Pacific Islands through a plethora of haplogroups, representing mainly [Caucasoid](#) and [Mongoloid](#) peoples. (I intend no offense by the use of these traditional regional genetic categories; they are simply more precise than the alternatives. See footnote [22](#).) However, they also make up a large part of the ancestry of the black-skinned peoples of New Guinea and Melanesia through Haplogroups K and M. And they are even found in Africa in the genetically exceptional [Chadic](#) people with [haplogroup R1b \(R-M343\)](#), who presumably migrated to central Africa from Eurasia and adopted Afro-Asiatic languages. They are [black-skinned](#), though most of haplogroup R are white Europeans, including the original Indo-Europeans. Who would have thought! So again we see that the Y-chromosome is no determiner of race!

²⁶ However, the article by [Thomas C. Curtis](#), for which he provides a link, is much less well thought through, and I disagree with many of his conclusions. I can vouch for the fact that Boström's own chart comparing haplogroups and language groups that follows is fairly accurate, though I might adjust a few details.

6.2.3. Ham

And under this structure the descendants of Ham are represented by haplogroups A through H on [Map 3](#) and [Map 4](#). Many of these (haplogroups A, B, and E) remain in Africa, but many do not, including haplogroup C (Asia, the Americas, Australia, and the Pacific Islands), haplogroup D (certain Asian populations), haplogroup G (small populations in the Caucasus, Middle East and Europe²⁷), and haplogroup H (India). Haplogroup F itself (conventionally called F*), not counting its “descendants”, [GHIJK](#) and [HIJK](#) (which we will now consider its ancestors) and [G](#) and [H](#), is almost non-existent, found very occasionally in Asia and Europe.

So, although in Genesis 10 the descendants of Ham are largely confined to Africa, this evidence would suggest that a number of Ham’s later descendants ranged farther afield.

7. Are the Mutations Really “Reversible”?

So this restructuring seems to fit all of the data, very nicely.²⁸ But is Boström’s key assumption valid scientifically?

Boström’s assumption is pretty far-reaching: that at any particular place of differentiation in the Y chromosome it is not necessarily clear which of the two states²⁹ represents the mutated state and which represents the prior state, so that we need additional information to determine the direction of any haplogroup tree.³⁰ Is this true? I am not a geneticist, but instead a cross-cultural missionary and linguist with some expertise and experience in historical and comparative linguistics, so geneticists will need to help answer that question.

It seems that this is certainly *sometimes* true, sometimes at critical points in a genetic tree. I was very surprised to read the following in the Wikipedia article on [Y-chromosomal Adam](#), in a discussion of mutations shared by humans and chimpanzees, which apparently are important in determining where the Y-chromosome tree starts:

The M91 and P97 mutations distinguish Haplogroup A from Haplogroup BT. Within Haplogroup A chromosomes, the M91 marker consists of a stretch of 8 T nucleobase units. In Haplogroup BT and chimpanzee chromosomes, this marker consists of 9 T nucleobase units. This pattern suggested that the 9T stretch of Haplogroup BT was the ancestral version and that Haplogroup A was formed by the deletion of one nucleobase. Haplogroups A1b and A1a were considered subclades of Haplogroup A as they both possessed the M91 with 8Ts.

But according to Cruciani et al. 2011, the region surrounding the M91 marker is a mutational hotspot prone to recurrent mutations. It is therefore possible that the 8T stretch of Haplogroup A may be the ancestral state of M91 and the 9T of Haplogroup BT may be the derived state that arose by an insertion of 1T. This would explain why subclades A1b and A1a-T, the deepest branches of Haplogroup A, both possess the same version of M91 with 8Ts. Furthermore Cruciani et al. 2011 determined that the P97 marker, which is also used to identify Haplogroup A, possessed the ancestral state in Haplogroup A but the derived state in Haplogroup BT.

The implication here is that it is not clear whether haplogroup BT should be the start of the human Y-chromosome tree, or haplogroup A, and in fact that BT seems to be a better candidate from an evolutionist’s point of view, because BT shares the ancestral state of a certain mutation with chimpanzees. However, be-

²⁷ However, [prehistorically](#) it seems to have had a large presence in Europe before being largely displaced, mainly by haplogroups I and R. [Ötzi the Iceman](#) has haplogroup G.

²⁸ Boström’s article seems to have gone practically unnoticed, which surprises me, considering that it is the closest thing to a solution I have found yet, which is why I want to make it known.

²⁹ These represent mutations in the [alleles](#) of a particular gene.

³⁰ Boström does not put it exactly this way, but it seems clear that this is what he means. He says, “Since the original Y chromosome DNA in Noah is not known the starting point in the haplogroup tree can be at any point. It does not have to begin in haplogroup A as usually is assumed when drawing the haplogroup tree.”

cause “the region surrounding the M91 marker is a mutational hotspot”, this means that we can assume that the same mutation happened in Chimpanzees and in haplogroup BT.

This suggests that 1) it is not always clear which is the mutated state and which is the ancestral state, and 2) some important mutations may occur more than once, making it unclear if the same mutation necessarily points to a single point on any genetic tree.³¹ This provides two different ways of casting doubt on the shape of any given tree.

However, the question still remains: can we assume this uncertainty for nearly all mutations, such that we can reverse the direction of many genetic trees based on external data?

7.1. Initial feedback

I have asked a few people at Reasons to Believe (reasons.org) to review this article and help me answer the genetic question. Dr. Hugh Ross, a very busy man, kindly looked at it, and said, “I think you’ve got something here,” but his field not being primarily genetics, he did not feel able to give a definitive answer.

Subsequently Dr. Vaughn Mancha, a volunteer apologist for Reasons to Believe who is well versed in the field of genetics, read the article and replied, “Your article was fascinating and I do not disagree with your conclusions. It might be difficult at this time to match the data with Genesis 10 completely. It might be that all the data might not be in as of yet to really do a complete genetic phylogeny.”

So apparently the reversal idea is tenable, and we will see what further research and study brings.

8. Broader Implications of this Solution

If this solution indeed cannot be disproven on genetic grounds, it would have some fairly profound implications.

8.1. Out of Babel Instead of Out of Africa

First of all, in place of the broadly accepted [Out of Africa](#) theory of human origins, we would have an Out of Babel theory, with the flow of mankind from Mesopotamia *into Africa* and other areas.³²

One area of evidence which might seem to oppose this theory is that Africa apparently contains significantly greater human genetic diversity than other parts of the world. According to a [2009 study](#), “African and African American populations... show the highest levels of within-population genetic diversity... In addition, genetic diversity declines with distance from Africa..., consistent with proposed serial founder effects resulting from the migration of modern humans out of Africa and across the globe...”

In fact, as we can see from [Table 7](#), even under the Out of Babel theory the Hamitic arm of the tree shows much greater diversity than the other two arms, with the Semitic arm showing the least. However, there are many possible reasons for reduced genetic diversity for Shem and Japheth, including the possibility that far fewer of the early descendants of Shem and Japheth had numerous descendants, or that massive die-offs occurred, whether from disease, war, or slavery. So this does not in any way disprove the Out of Babel theory.

The fact that genetic diversity seems to generally decline with distance from Africa has completely different implications in our new tree, and could have various explanations, including the one given in the previous paragraph, or the possibility that populations spread out quickly in lands far from the origin, as certainly seems to have happened in the Americas, which seem to have been entirely populated in a very short time, at least according to the *short chronology theory*.³³

³¹ Boström also comments on this additional source of uncertainty: “There is also a possibility of the same SNPs occurring in different individuals in different lineages. [In the mitochondrial genome there are places where mutations reoccur frequently](#). So there may be locations along the Y chromosome with a higher probability of mutations, where mutations reoccur as well.”

³² The Out of Africa theory claims evidence from both Y-chromosomal and mitochondrial DNA, so such a radical change in the Y-chromosomal tree would also require rearrangement of the mitochondrial tree. However, if the rationale for the change is valid, there is nothing to preclude such a rearrangement for the mitochondrial tree as well. However, we have of course no biblical data to shed light on this question, since all genealogies in the Bible follow male lineages.

³³ en.wikipedia.org/wiki/Settlement_of_the_Americas#Chronology

8.2. Younger Dating for Mankind

Another implication would be that mankind would be much younger than is implied by the current genetic trees, in fact roughly half as old as most current estimates, as we can see by comparing [Table 3](#) with [Table 7](#), because even with the greater complexity of the Hamitic line noted above, the time each of the three branches actually occupied would necessarily be the same, the time from Shem, Ham, and Japheth to the present. Thus the dating of mankind would actually match the current estimate of the Out of Africa migration.

9. Tables and Maps

Table 2: Table of Nations from [Genesis 10](#)

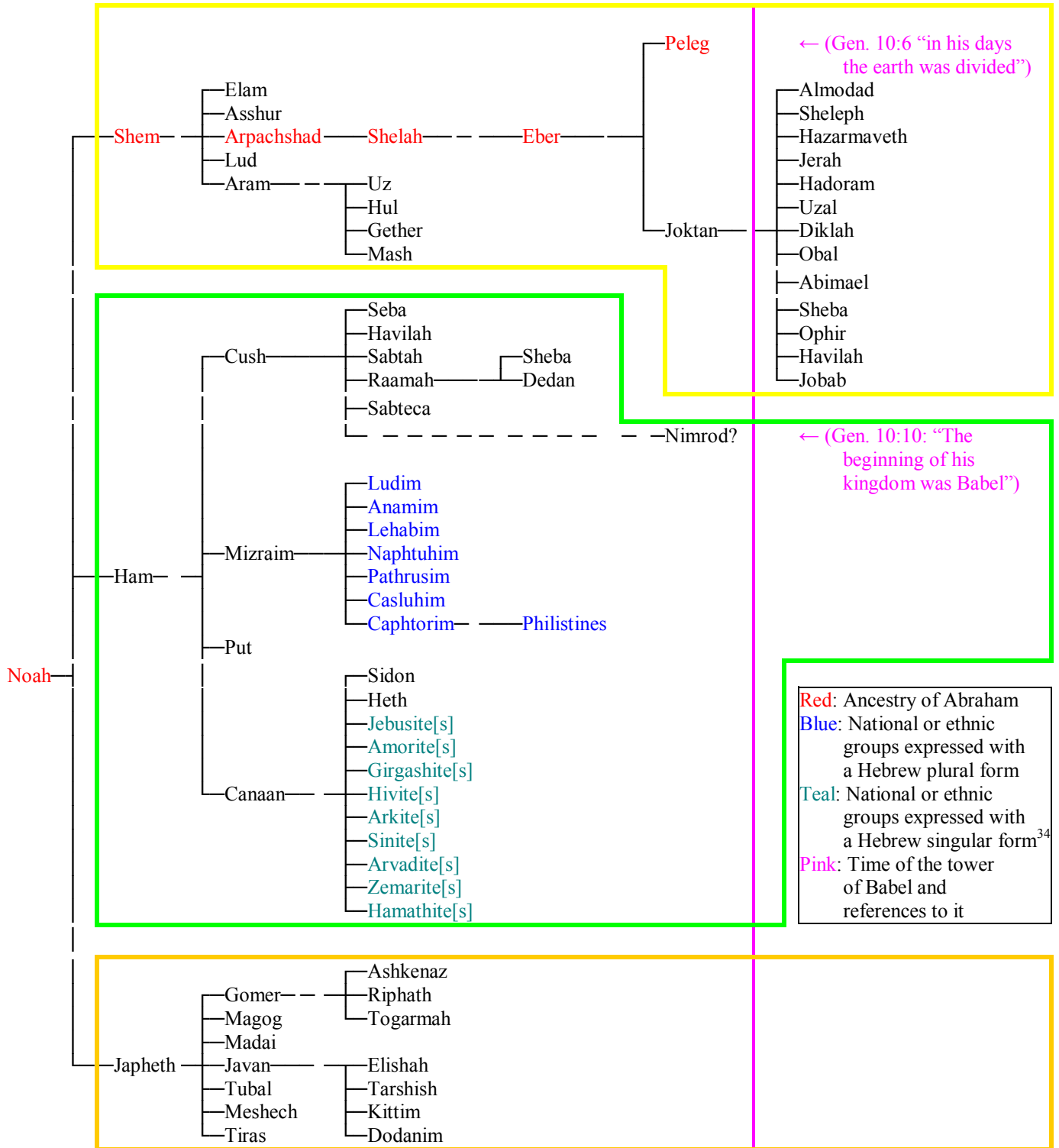

³⁴ The New American Standard Bible translates all of these as singulars, reflecting the Hebrew. Most of these mean “native of X city.”

Table 3: Human Y-chromosome DNA (Y-DNA) Haplogroups

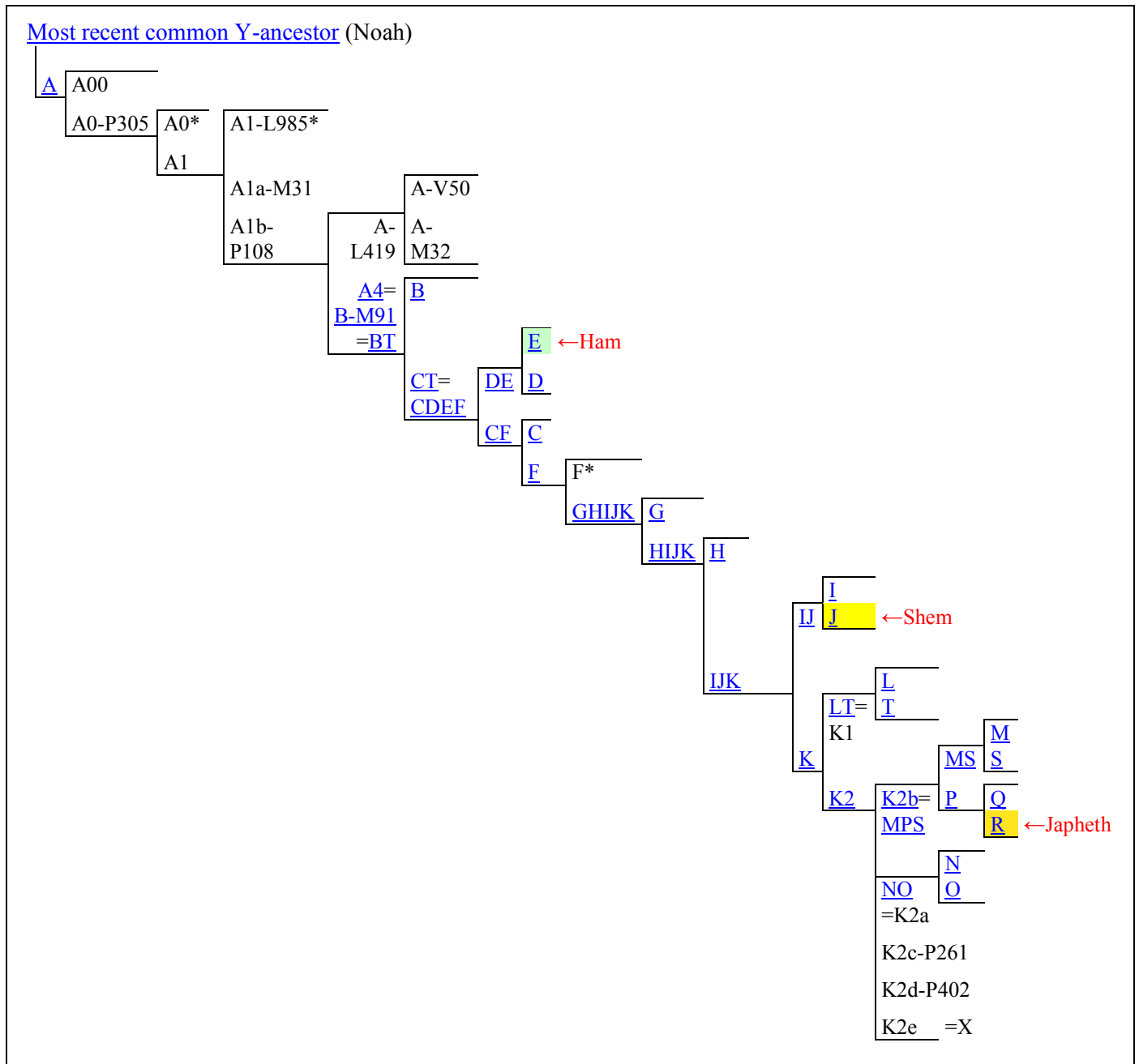

Adapted from en.wikipedia.org/wiki/Human_Y-chromosome_DNA_haplogroup (Updated 5-May-2016.)

Highlighted haplogroups in chart:	E:	All Afro-Asiatic languages except part of Semitic, all Niger-Congo languages
	J:	Descendants of Shem, including a large percentage of modern Jews and most Mideastern populations, including the original Arabs
	R:	Original Indo-Europeans and some other Eurasian peoples

Map 1: Map of Nations from Genesis 10: Location Probabilities

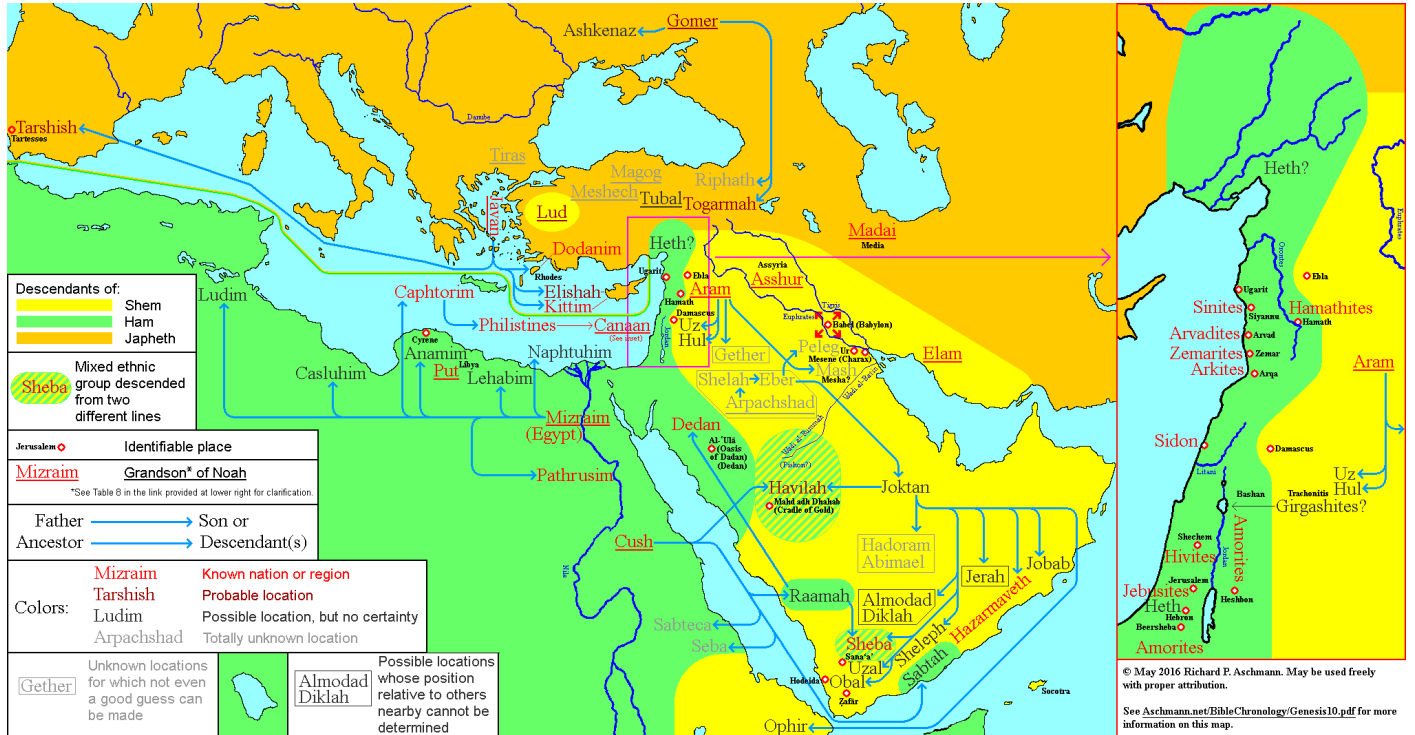

Map 2: Section of Map 3 centered on Mesopotamia

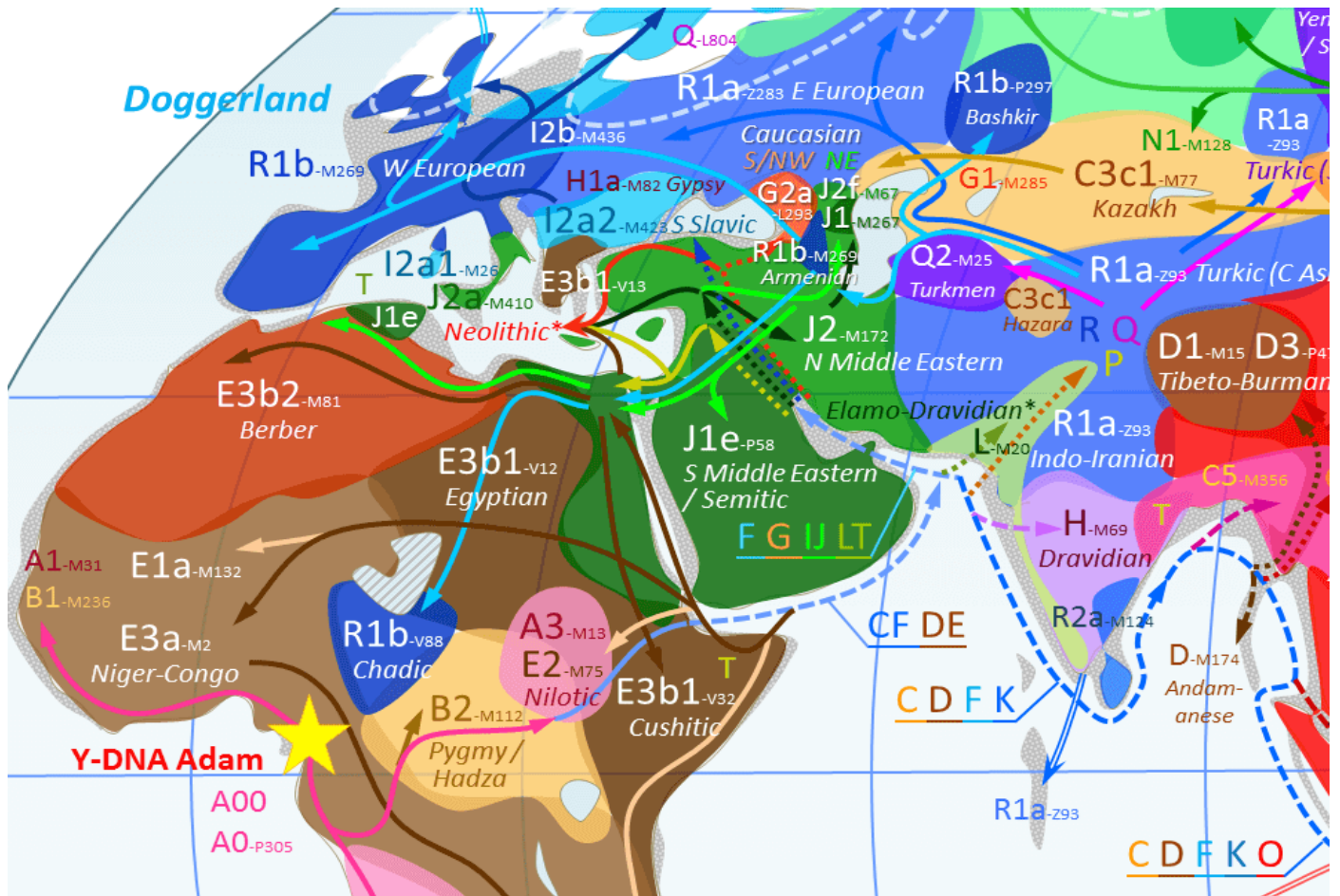

Table 4: Some Haplogroup Names used on Maps 2 and 3 and Their Unambiguous Equivalents

Haplogroup names have gone through so many changes that older names are now often ambiguous, the same name having been used with different meanings. Currently the simplest way of clarifying the name of a haplogroup is to specify its defining mutation. Some of the names used on the maps are quite archaic. Those items on the tree and in the chart that are listed on the maps have a yellow background.

Name used on maps	Currently accepted name (defining mutation(s))	Main area or ethnic connection
E	E-M96	(remnant populations except descendants)
E1	E-P147	(nonexistent except descendants)
E1a	E-M33/E-M132	Mali+
E1b	E-P177	(nonexistent except descendants)
E1b1	E-P2	(nonexistent except descendants)
E1b2	E-P75 *	(rare)
E1b1a	E-V38/E-M2	Niger-Congo languages
E1b1b	E-M215	(nonexistent except descendants)
E1b1b1	E-M35 *	Afro-Asiatic languages but not Semitic languages
E1b1b2	E-M81	Berber peoples and languages , part of Afro-Asiatic languages .
E3b1	E-V68/E-M78	Balkans
E2	E-M75/E-P68	remnant populations in Africa
J	J-P209	Socotra, rare elsewhere except descendants
J1	J-M267	Arabia, Sinai, Sudan, Tunisia, Northeast Caucasian languages , many Jews
J1c3 or J1e	J-P58	The Cohen Modal haplotype, marker of descent from Aaron. Time estimates indicate sometime in the second millennium B.C. (Abraham's would either be identical, or have fewer mutations.) ³⁵
J2	J-M172	Mesopotamia+
R	R-M207	(rare except descendants)
R1	R-M173	(rare except descendants)
R1a	R-M420	Western Asia, Eastern Europe, Indo-European languages (probably the original speakers), some Turkic
R1b	R-M343	Mostly Western Europe, though also Asia and Africa
R2	R-M479	(rare except descendants)
R2a	R-M124	South Asia, Dravidian languages and others

* These defining mutations do not have their own Wikipedia article or subarticle, so the information about them must be gleaned from the parent article.

³⁵ 617 years probably separated Abraham (born about 2166 B.C.) and Aaron (born about 1549 B.C.) (see [Aschmann.net/BibleChronology](#)). We do not know how many generations intervened (see [Aschmann.net/BibleChronology/BibleGenealogies.pdf](#)). [Helgason, et al](#) suggest, based on their recent study of Icelandic men, that a Y-chromosome mutation may occur about once every two generations: “relatively few *de novo* mutations are observed per generation (an average of 0.59, where 35% of branches had none)”, or on the average one every 34.5 years, which I derived from their figures of “1,365 meioses (47,123 years)”. (Both figures must be taken into account, since “Three studies showed that variation in the number of new mutations carried by offspring is primarily determined by the age of the father at the time of conception.”

Based on this, some mutations very likely occurred between Abraham and Aaron, probably many.

Table 5: Tree of Haplogroup E subclades shown on maps 2 and 3

The haplogroups listed in the previous table are sufficiently confusing that I found it necessary to include the tree below as well.

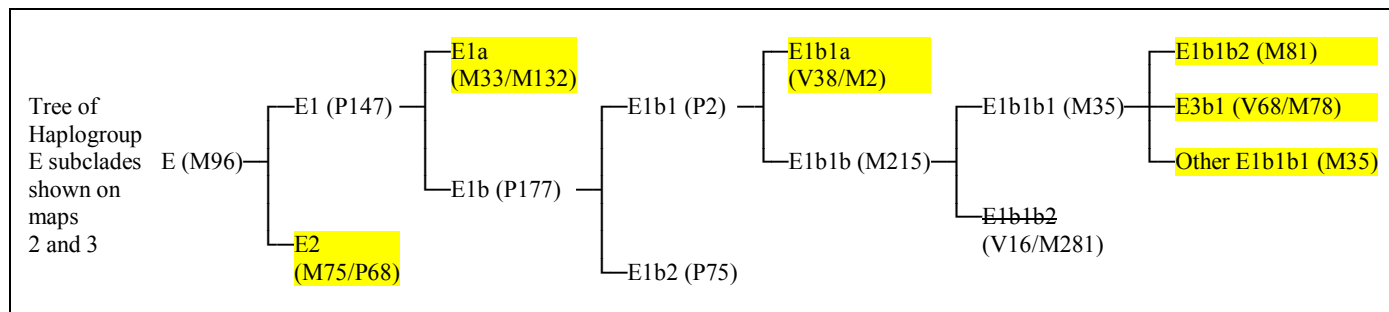
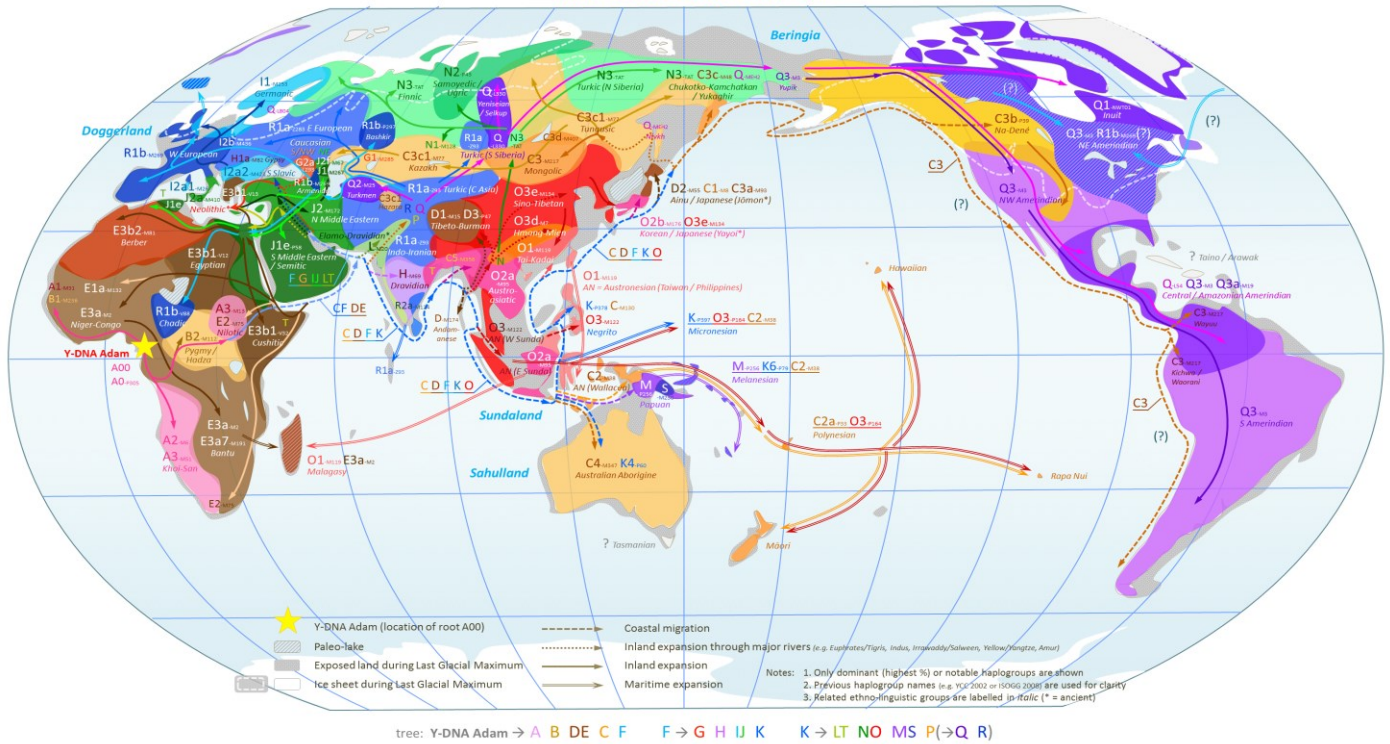

Table adapted and expanded from upload.wikimedia.org/wikipedia/commons/3/3d/E1b1b_ancestry.png. See en.wikipedia.org/wiki/Haplogroup_E-M215%28Y-DNA%29#Subclades_of_E-M215 for more information.

Map 3:

World Map of Y-DNA Haplogroups
Dominant Haplogroups in Native Populations
with Possible Migration Routes



upload.wikimedia.org/wikipedia/commons/c/ca/World_Map_of_Y-DNA_Haplogroups.png

Map 4:

Approximate Current Spread of Descendants of Shem, Ham, and Japheth throughout the World, According to the Out of Babel Theory

Adapted from the map at upload.wikimedia.org/wikipedia/commons/c/ca/World_Map_of_Y-DNA_Haplogroups.png, with original haplogroups unchanged, and original migration routes left unchanged even when they should be reversed, in particular those in Africa.

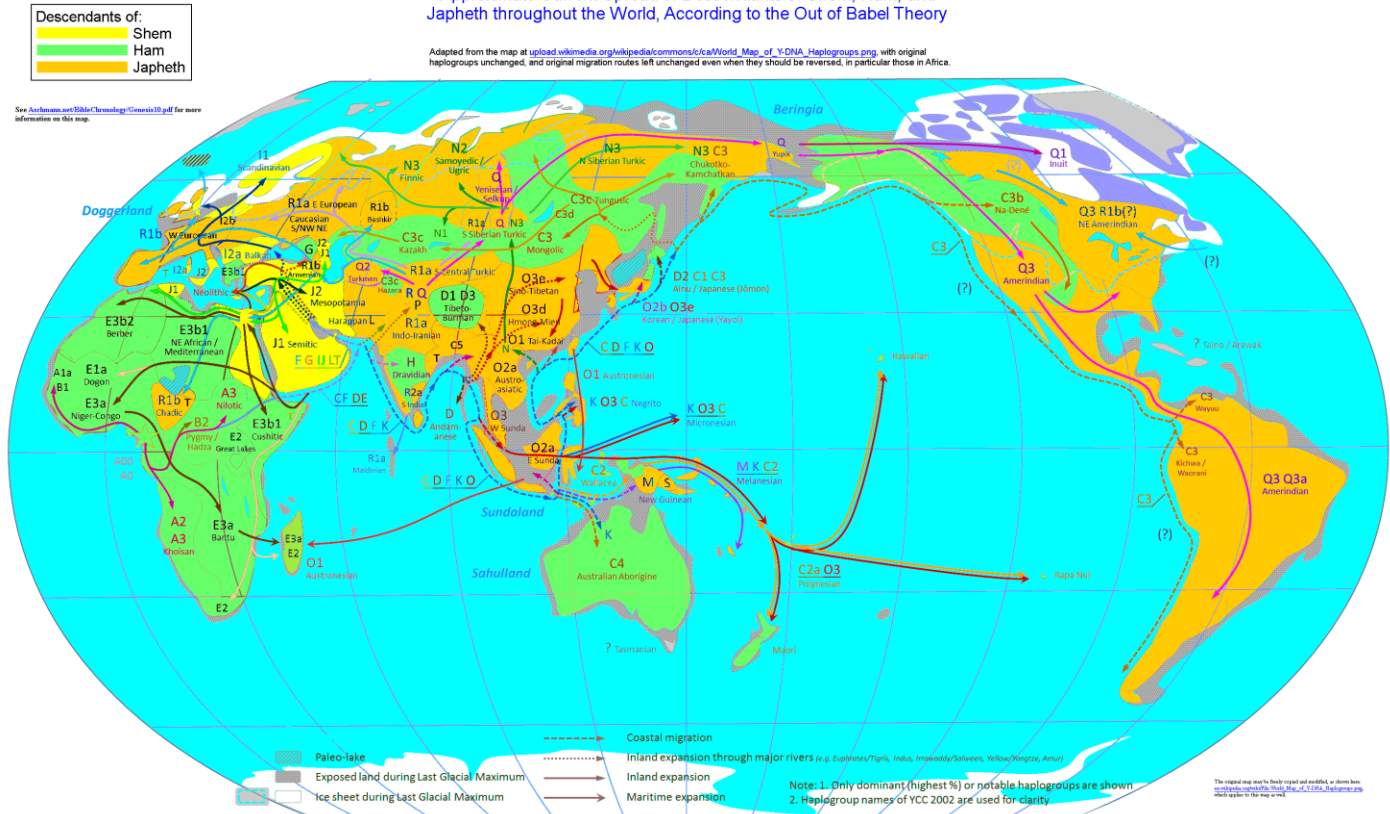

Map 5: [Map](#) of Semitic Languages in Ancient Times

Semitic Languages in Ancient Times

Ebla's situation is unclear: it seems to have had a native West Semitic population, though its literary language in the 3rd millennium B.C. was closer to Akkadian, and this also changed through time.

(Attested through Akkadian proper names in Sumerian texts beginning at around 2800 B.C., written from around 2500 B.C. until the 1st century B.C., though probably extinct as a native spoken language by the 8th century B.C.)



Table 6: Leif A. Boström's Rearrangement of the Y-Chromosome Tree

This tree and a discussion of it can be found at [familjenbostrom.se/genealogi/dna/dna table of nations.htm](http://familjenbostrom.se/genealogi/dna/dna%20table%20of%20nations.htm).

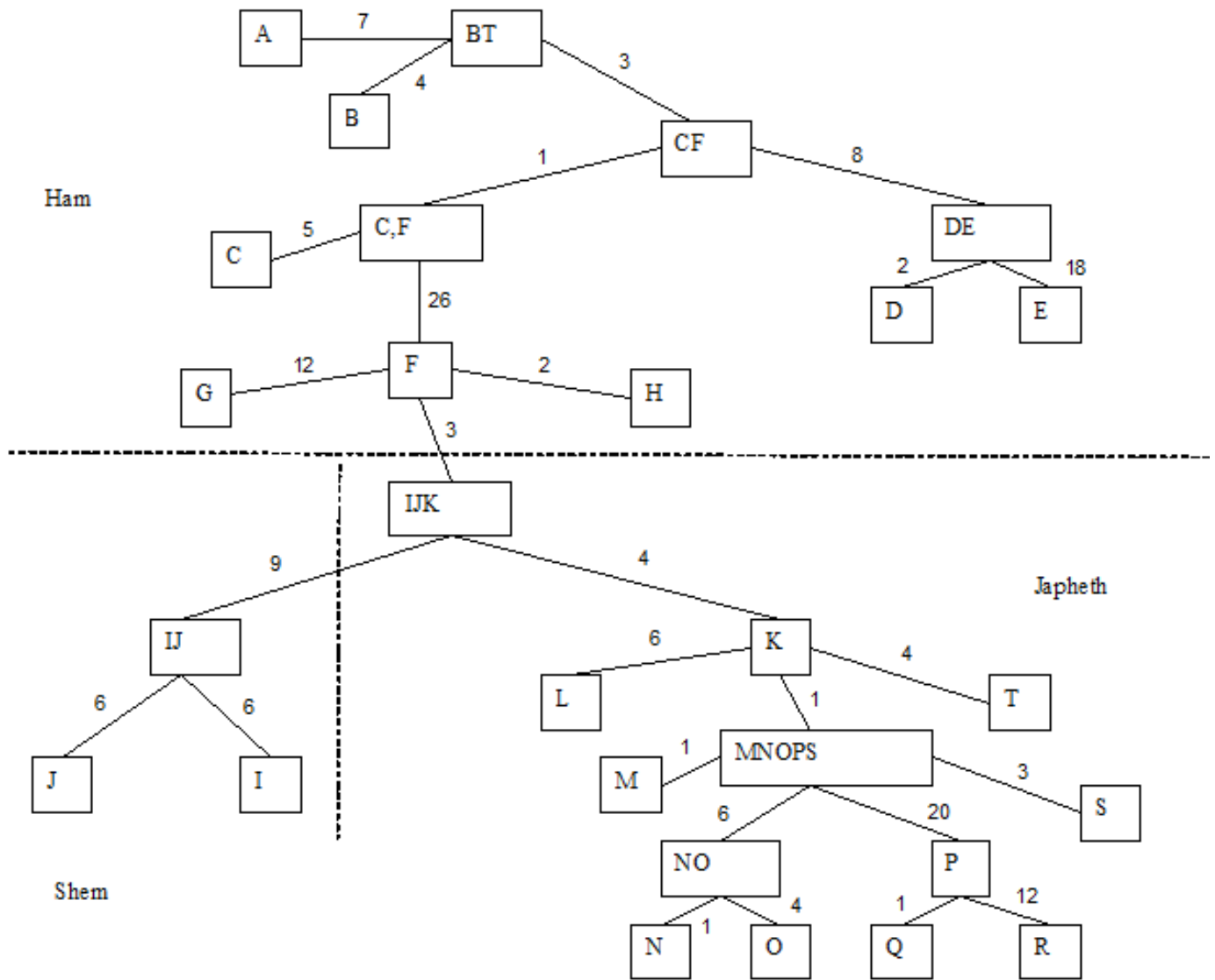
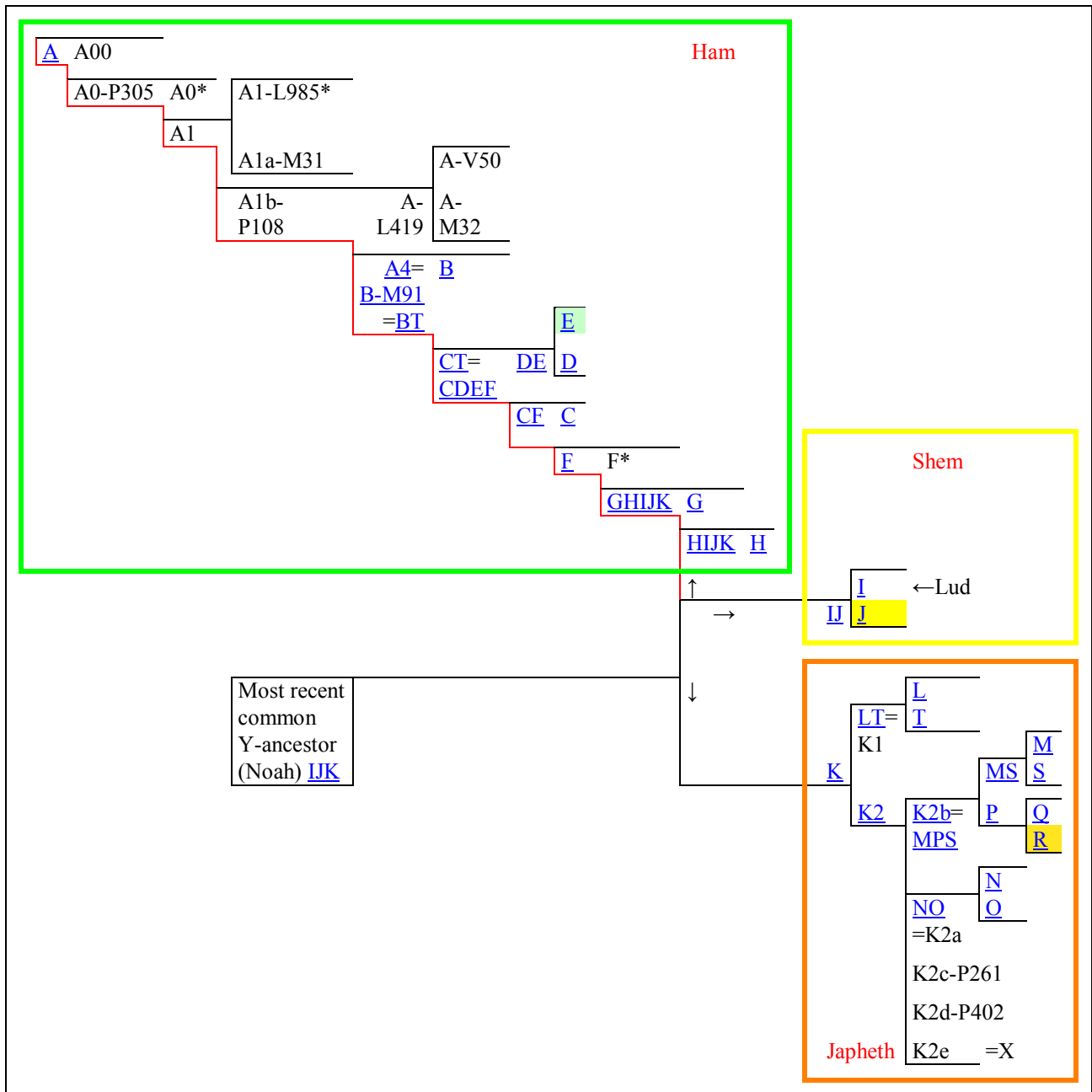

Table 7: Human Y-chromosome DNA (Y-DNA) Haplogroups Rearranged



Adapted from [Table 3](#) (Updated 5-May-2016)

Highlighted haplogroups in chart:	E:	All Afro-Asiatic languages except part of Semitic (including all descendants of Ham mentioned in Genesis 10; see §6.1), all Niger-Congo languages
	J:	Most descendants of Shem, including a large percentage of modern Jews and most Mideastern populations, including the original Arabs
	R:	Original Indo-Europeans and some other Eurasian peoples, (including probably all descendants of Japheth mentioned in Genesis 10; see §6.1)

The preceding table is simply [Table 3](#) restructured to reflect the new starting point for Noah, and the reverse structure of the Hamitic tree, mostly following Boström but keeping all the nodes in the latest revision of Table 3. The part of the backbone of the (Hamitic) tree in which the mutations have been reversed is marked in red. The side branches have not been reversed. (In updating the tree I realized that some of my branching in the Hamitic tree was wrong, and that I hadn't followed Boström properly, so I readjusted it.)

Table 8: Detailed Analysis of [Genesis 10](#), with Identities and Languages

Most of the information in the table below is taken from [Beitzel](#), or from the verses or links provided, or from the corresponding Wikipedia article, comment added by yours truly. I have recently (July 6, 2015) added suggestions from Fruchtenbaum (pages 203-221)³⁶ for locations of otherwise unidentifiable peoples, though for the most part his ideas do not differ from Beitzel.

Many of the genealogies in the Bible are not complete, and this was well understood by the original Israelite readers. This is explained at length in [Aschmann.net/BibleChronology/BibleGenealogies.pdf](#), [reasons.org/files/articles/The-Genesis-Genealogies.pdf](#), and [reasons.org/articles/from-noah-to-abraham-to-moses-proof-of-genealogical-gaps-in-mosaic-literature-part-1](#). Thus “father” often simply means ancestor, and “son” means descendant, throughout the Bible, as when Jesus is referred to as the “son of David”. So we cannot necessarily assume, for instance, that Peleg was the great-great-grandson of Shem: there may have been many more generations separating them. We can only know the actual number of generations if Scripture provides this information independently of the genealogy. Thus we know that Terah really was Abraham’s father not from Genesis 11:26, part of the genealogy, but from Genesis 11:27-31, which makes very clear the actual relationships.

Not only that, but, as already discussed in §3 and its subsections, it need not be assumed that all of the names in Genesis 10 refer to individuals: some may refer to descendant nations. Thus, it is very probable that Sheba refers to a people group that had a mixed descent from both Shem and Ham, as discussed below and shown on Map 1,³⁷ and the same is probably true of Havilah. And of course it is quite clear that some of the names do *not* refer to individuals but to ethnic affiliations, as in the case of the names colored [blue](#) or [teal](#) in [Table 2](#), but it is unclear which category the rest fall into.

Thus, on the top of the chart below the indication “Minimum Generations from Noah” means just that, and there could in fact have been many more generations separating them. And on [Map 1](#) the term “Grandson* of Noah” simply means the names in the third column of the table below, whether they were actually Noah’s grandsons or later descendants.

Colors: Red: Known nation or region Brown: probable location Charcoal: Possible location, but no certainty Light grey: Totally unknown location
--

³⁶ On the website all of the printed pages are given page numbers in the web address which have 30 added to them. For example, printed page 203 has web address <http://librarun.org/book/21802/233>, with 233 instead of 203. I will refer to the printed page numbers, though the links will necessarily be adjusted as indicated

³⁷ The map and the chart show that Sheba was composed of both descendants of Joktan descendant of Shem and Raamah descendant of Ham. However, Genesis 25:2 suggests that some descendants of Abraham’s son Jokshan may also have become major contributors to the Sheba community, though this would again have been many millennia later.)

1	2	3	4	5	6	← Minimum Generations from Noah Location and Identification	Language & Family
Shem 26	Arpachshad	Shelah	Eber	Peleg		“father of all the children of Eber” (Gen. 10:21)	
						<p>Ancestor of Abraham. “...in his days the earth was divided” (Gen. 10:25). Most commentators³⁸ feel that this phrase refers to the division of the languages at the Tower of Babel. However, Hugh Ross³⁹ suggests that this more likely refers to the time of the inundation of the land bridges at the Bering and Hecate Straits because of rising sea levels after the last ice age, and gives some good arguments in favor of his position. Much as I respect Dr. Ross, I am not convinced, and have tentatively followed the former.</p> <p>Because Abraham is his descendant, in fact his family constitutes the only known descent line, and because Abraham spoke Aramaic as his native language and had the lifestyle of a Bedouin, but came from Ur, a city whose inhabitants spoke Akkadian or Sumerian, this makes me wonder if his people did not actually live in the city of Ur, but instead were nomads or Bedouins as they were later, living in the desert near the city. This article suggests that this is the case, and in fact makes the suggestion that the Chaldean people were also nomads or Bedouins at this time, living around the city rather than in it, that they spoke Aramaic, and that they may have been Abraham’s relatives: www.tms.edu/m/tmsj20a.pdf. I have tried to show this on Map 5 by extending the area of Aramaic through the Syrian Desert down to just west of Ur. However, the situation was probably more complicated than this! The whole area was desert except where it was irrigated, and nomads probably traveled freely throughout the area.</p>	Aramaic
				Joktan		<p>All identifiable descendants seem to be located in the southern Arabian Peninsula (except Havilah in the central part of the peninsula, and possibly Ophir, which according to Beitzel scholars usually locate in Africa). Gen. 10:30 provides some confirmation of this: “The territory in which they lived extended from Mesha in the direction of Sephar to the hill country of the east.” Sephar (Hebrew סֶפָר <i>sēpār</i>) could possibly be Zafar, Yemen (Arabic ظفار <i>Zafār</i>),⁴⁰ and the best possibility for Mesha seems to be Mesene, modern-day Kuwait, following Beitzel and Josephus.</p> <p>Fruchtenbaum (page 219) associates all of Joktan’s sons with Arab tribes, but he does not indicate his sources, and these cannot always be pinned down geographically.</p>	Mostly South Semitic languages
				Almodad		“...the South Arabian people of the Tribe of Al-Mudad in Yemen” (Fruchtenbaum). However, this only shows them to be South Arabian, but not which part of Yemen.	
				Sheleph		Salipeni?, between Sheba & Hadramaut (Fruchtenbaum)	
				Hazarmaveth		הַצַּרְמָוֶת <i>hāṣarmāwet</i> = Hadramaut حضرموت <i>Haḍramawt</i> , ⁴¹ eastern Yemen	Hadramautic

³⁸ E.g. see the different commentaries about this verse at <http://biblehub.com/commentaries/genesis/10-32.htm>, especially Gill. Wiseman in the *New Bible Dictionary* expresses the same opinion.

³⁹ *Navigating Genesis*, chapter 7, Kindle locations 1260 and 1263, and chapter 19, Kindle locations 3226, 3230, and 3234.

⁴⁰ However, as Mitchell points out in the *New Bible Dictionary*, the first letters of each do not correspond, so there can be no certainty: Hebrew ס *s* [s] descended from a different Proto-Semitic consonant than Arabic ظ *z* [zʕ]. See my article [Semitic Alphabets](#) for more details.

⁴¹ Hazarmaveth (Hebrew הַצַּרְמָוֶת, traditionally transliterated *hāṣarmāwet* (the dots under the *h* and the *s* and under other letters below indicate special [pharyngeal](#) or [pharyngealized](#) consonants), original pronunciation probably [hasʕarmawet]) and [Hadramaut](#) (Arabic حضرموت, traditionally transliterated *Haḍramawt*, pronounced [hadʕramawt]) both derive from the identical Proto-Semitic name following standard sound changes. The fact that their vowels are slightly different is unimportant in Semitic languages, in which only the consonants determine the root. The original second consonant would have been Proto-Semitic [ʕʕ], which always became *ḥ* [dʕ] in Arabic and *ṣ* [sʕ] in Hebrew (modern pronunciation [ts]). The original [Hadramautic](#) speakers would have retained the [ʕʕ], as do the speakers of the Modern South Arabian languages today, who probably use this sound in this name even

				Jerah	“...the Jerakh next to the Hazarmaveth” (Fruchtenbaum)	
				Hadoram		
				Uzal	Arab tradition: Sana'a (<i>Ṣan'ā' [sʕanʕaːʔ]</i>), Yemen	
				Diklah	“Date palms”. Yemen (Fruchtenbaum).	
				Obal	Abil, Yemen, near Hodeida ?	
				Abimael		
				Sheba	Sabaeen kingdom, Yemen. (Also Ham.)	Sabaeen
				Ophir	Somaliland? Ethiopia?	Ethiopian ??
				Havilah	See map 1 and Map 5 . ⁴² (Also Ham.)	Arabic ??
				Jobab	SE Saudi Arabia? (Beitzel, Fruchtenbaum)	MSA ?? ⁴³
	Elam					Elamite
	Asshur				Assyria	Akkadian
	Lud				Possibly Lydia in Asia Minor, but earlier language unknown	
	Aram					Aramaic
		Uz			Trachonitis ? (Josephus) ⁴⁴	
		Hul			Leja? (Trachonitis ?) (Josephus: Armenia) ⁴⁴	
		Gether			?? (Josephus: Bactria) ⁴⁴	
		Mash			Mesene? ⁴⁴	
Ham						
	Cush				Nubia	Cushitic
		Seba				
		Havilah			See map 1 . ⁴² (Also Shem.)	Arabic ??
		Sabtah			Western Hadramaut?	
		Raamah			רַמָּה <i>ra'mā</i> , Septuagint Ρεγμα or Ρεγμα, suggesting the ר (‘) is not [ʕ] but [ʁ]. ⁴⁵	
			Sheba		Sabaeen kingdom, Yemen. (Also Shem.)	Sabaeen
			Dedan		Northwestern Saudi Arabia	Dadanitic
		Sabteca				

today, since they lack the [dʕ] sound, though I have not been able to verify this. See my article [Semitic Alphabets](#) for more details. The original pronunciation in Proto-Semitic and Hadramautic would probably have been something like [haʕ'aramawet].

⁴² Here I have followed Dr. Hugh Ross’s Gulf Oasis theory, which places the Garden of Eden within the Persian Gulf, which would have been dry at the time, and which is explained in [reasons.org/articles/lost-civilization-beneath-the-persian-gulf-confirms-genesis-history-of-humanity](#) and discussed at length in his book *Navigating Genesis*, in identifying the Pishon River, identified in Genesis 2:10-12 as flowing out of Havilah, as the [Wadi Al-Batin](#) and its upstream extension the [Wadi al-Rummah](#). I have also used some information from [en.wikipedia.org/wiki/Havilah](#) regarding location evidence for Havilah based on clues in Genesis 1, in particular the [Cradle of Gold](#) and the headwaters of the Pishon. (Others who, in discussing the four rivers of Genesis 2:10-14, have suggested this identification for the Pishon are [Kenneth Kitchen](#) and [Juris Zarins](#), though they identify a different river for the Gihon than Ross does. [Jeffrey Rose](#) also proposed a Gulf Oasis theory with a dry Persian Gulf, and mentions the Wadi El-Batin, though he doesn’t associate it with the Genesis rivers.)

⁴³ Based simply on his apparent location, it seems likely that the descendants of Jobab may have spoken the ancestors of the [Modern South Arabian languages](#), which were apparently never written until modern times, but which, based on linguistic evidence, evidently separated from the rest of the [South Semitic languages](#) early, and diverged into their own subfamily (see [Map 5](#)), suggesting that Jobab or his descendants may have separated early on from his brothers’ descendants.

⁴⁴ All of this information about Aram’s sons is from [Fruchtenbaum, page 218](#). Though Josephus said that Hul was Armenia, the Armenians’ own tradition says that [Togarmah](#) descendant of Japheth was their ancestor, and Fruchtenbaum says, “... more likely, he was located in the Leja region”, though he does not say why he thinks so. He seems to imply that Trachonitis and Leja are distinct, but apparently they refer to the same region.

⁴⁵ See my article [Semitic Alphabets](#), page 6, for an explanation of how some Hebrew letters represented two distinct sounds. Beitzel associates Raamah with “Ragmah of Sabeen inscriptions”, and tentatively locates it in extreme southwest Saudi Arabia, but [Wikipedia](#) says, “It has been connected with Rhammanitae mentioned by Strabo in the southwest Arabian Peninsula, and with an Arabian city of Regmah at the head of the Persian Gulf.” I cannot track down any more information on these references.

	Nimrod?				His status is confusing: he is not listed with the sons of Cush in Genesis 10:7 or 1 Chronicles 1:9, suggesting that the proper translation in Genesis 10:8 and 1 Chronicles 1:10 might be “Cush was the ancestor of Nimrod.” However, in that case the natural thing would have been to tell us which son he descended through, which it does not. Also, he seems to have lived far from the traditional area of most of the descendants of Cush, in fact in the heart of Mesopotamia, an area which continued to be associated with him (Micah 5:6). However, the simplest solution is that he was probably not actually a son of Cush, but a later descendant, and that it isn’t significant which son of Ham he descended from, that he lived earlier than the division of the nations at Babel, or at that time, before the nations dispersed, and that he did not found his own nation through his own offspring, but built an empire by ruling over other nations. Josephus and others have credited him with instigating the building of the Tower of Babel, though the Bible does not actually say this. Even so, this might explain the other comments about him, including that he built Babel/Babylon and other cities of Shinar (Sumer) and of Assyria (Genesis 10:10-11).	
Mizraim (Egypt)						Egyptian
	Ludim				North Africa, presumably	
	Anamim				“...connected with Cyrene. This is the Anami of the inscriptions of Sargon II” (Fruchtenbaum, page 214)	
	Lehabim				Libya/Egypt? (Fruchtenbaum, page 214)	
	Naphtuhim				Nile delta?	
	Pathrusim				Pathros = Upper Egypt (southern Egypt)	
	Casluhim				Apparently somewhere in Africa	
	Caphtorim →Philistines				Crete, apparently well established. This passage and 1 Chr. 1:12 seem to suggest that the Philistines came from the Casluhim, not the Caphtorim, but other passages clearly connect the Philistines to the Caphtorim (Deut. 2:23, Jer. 47:4, Amos 9:7), so this seems to actually be what is intended here.	Mycenaean Greek?
Put					Or Phut: Libya	Berber
Canaan					Occupies the entire east coast of the Mediterranean! In Gen. 10:19 it says that Canaan’s territory only reached as far north as Sidon, but five of the cities listed for Canaan in the preceding verses are quite a ways north of Sidon, as can be seen in the inset on Map 1 . Perhaps the boundaries given in verse 19 are only intended to indicate the heartland of the Canaanites. Alternatively, perhaps these five cities and other Canaanite-speaking cities up north like Ugarit were settled later than the others, which might be the meaning of the comment “Afterward the clans of the Canaanites dispersed” in verse 18.	Canaanite
		Sidon his firstborn			Phoenicia	
		Heth				NIV has “Hittites” in Gen. 10:15, but the Hebrew and ESV have simply Heth. In Genesis they are found often in the set phrase הַתּוֹכְנֵי הֵטֶל <i>həṯōkənē-hêṭl</i> “(the) sons of Heth” (or in Gen. 27:46 הַבָּנוֹת בְּנֹת הֵטֶל <i>bə-nō-wl hêṭl</i> “daughters of Heth”), though never elsewhere. More often הִיִּטִּי <i>hitti</i> “Hittite”, which occurs even in the same Genesis passages. Beitzel suggests that these were the “ neo-Hittite principalities in Syria”, but these did not come about until about 1180, which is rather late for most of the Biblical references. The earlier Hittites who founded an empire in central Anatolia were Indo-Europeans, not Canaanites! In any case the Bible mainly locates them in Canaan. There are, therefore, those who assume that these are distinct from the Hittites of the Hittite Empire or their successors, and I probably lean in that direction, though a couple of late references (2 Kings 7:6, 2 Chronicles 1:17) do seem to be to the neo-Hittite principalities .

		Jebusites			Jerusalem	
		Amorites			In the Bible they are described as living in various parts of the Hill country and in trans-Jordan. History tells us that the Amorites also played a significant role at different times in the history of Mesopotamia, and may have originated somewhere in the Syrian Desert.	
		Girgashites			Gergasenes?	
		Hivites			Shechem area (Gen. 34:2)	
		Arkites			Phoenicia, Arqa , north of Tripoli	
		Sinites			Phoenicia, Between Ugarit and Arvad	
		Arvadites			Phoenicia, Arvad (Modern Arwad), Syrian coast.	
		Zemarites			Phoenicia, Zemar , Between Arvad and Tripoli	
		Hamathites			Phoenicia, inland, Modern Hamra , Syria	
Japheth 14 “coastland peoples” “each with his own language”	Gomer				IE? : Cimmerians?	Cimmerian?
		Ashkenaz			IE? : Scythians? Phrygians?	Scythian?
		Riphat			Asia Minor?	
		Togarmah			Tegarama , eastern Turkey; IE? Kartvelian? Turkic?	Anatolian?
	Magog			Gyges king of Lydia? IE?	Lydian?	
	Madai			IE : Medes	Median	
	Javan			IE : Greeks: Ionians (Greek Ἴωνες <i>Iōnes</i> , Homeric Greek Ἰάωνες <i>Iáones</i> ; earlier *Ἰάπωνες <i>Iáwones</i>)	Greek	
		Elishah			Alashiya? Cyprus	Greek
		Tarshish			Tartessos in southwest Spain?	?
		Kittim			City of Kition in Cyprus	Greek
		Dodanim (Rhodanim)			Rhodes	Greek
Tubal			Asia Minor? Caucasian Iberia??	Kartvelian?		
Meshech			Mushki? Kartvelian? IE?			
Tiras			Thrace? IE? Etruscans? Tyrrhenian? Turusha?			

10. About the Author

I am a Christian missionary and a professional linguist, working for [Mission to the World](#) of the [Presbyterian Church in America](#) in Latin America since 1979, and was also ordained as a pastor (teaching elder) in 2014. I am trained as a Bible translator, and during more than half of my missionary career I also worked with [Wycliffe Bible Translators](#) under a cooperative agreement. I am also a missionary kid, son of Wycliffe translators in Mexico.

In my youth I was a theistic evolutionist, since that was the position my mother held. (My dad never would tell me his position, apparently keeping an open mind.) As I reached adulthood and developed my own commitment to the Lord, I swung clear to the opposite extreme, and became a young-earth creationist, a position I held for a number of years, though I saw early on that there were things that could not be explained, the one that seemed most glaring to me at the time being the light from distant stars. As time went by I saw more and more inconsistencies. Finally I realized that only an old earth fits the data, and that this does not conflict with a high view of the inerrancy of Scripture. At the same time I remained convinced that evolution was not scientifically justifiable, whether theistic or not. So, one day I did a Google search for “old earth creationist”, and found [reasons.org](#), whose web site and books have greatly helped and encouraged me.

My expertise is not at all in the area of human genetics, which is why I am only presenting the ideas in this article as a tentative explanation for the mismatch between Genesis 10 and the Y-chromosome tree. However, my expertise *is* in linguistics, and in particular in the area of comparative linguistics, in which I have published a book, [Proto-Witotoan](#) (1993, Summer Institute of Linguistics and University of Texas at Arlington). This book reconstructs the ancestral language, spoken several thousand years ago, of six indigenous languages spoken in the Amazonian areas of Colombia, Peru, and Brazil. Since these languages were not written until the 20th century, the only information we have about this ancestral language comes from the current state of its daughter languages, so that it required a lot of guesswork. Even so, by using rigorous methodology, I was able to do a reconstruction with a fair degree of confidence. But I like to compare the process to trying to put together a jigsaw puzzle in the dark: you can make it all fit, but you can never be ab-

solutely sure that you got it right because you can't actually see the picture! And this is probably a good description of all comparative reconstructions of dead languages.

11. Text of Genesis 10 (ESV)

¹These are the generations of the sons of Noah, Shem, Ham, and Japheth. Sons were born to them after the flood.

²The sons of Japheth: Gomer, Magog, Madai, Javan, Tubal, Meshech, and Tiras. ³The sons of Gomer: Ashkenaz, Riphath, and Togarmah. ⁴The sons of Javan: Elishah, Tarshish, Kittim, and Dodanim. ⁵From these the coastland peoples spread in their lands, each with his own language, by their clans, in their nations.

⁶The sons of Ham: Cush, Egypt, Put, and Canaan. ⁷The sons of Cush: Seba, Havilah, Sabtah, Raamah, and Sabteca. The sons of Raamah: Sheba and Dedan. ⁸Cush fathered Nimrod; he was the first on earth to be a mighty man.⁴⁶ ⁹He was a mighty hunter before the LORD. Therefore it is said, "Like Nimrod a mighty hunter before the LORD." ¹⁰The beginning of his kingdom was Babel, Erech, Accad, and Calneh, in the land of Shinar. ¹¹From that land he went into Assyria and built Nineveh, Rehoboth-Ir, Calah, and ¹²Resen between Nineveh and Calah; that is the great city. ¹³Egypt fathered Ludim, Anamim, Lehabim, Naphtuhim, ¹⁴Pathrusim, Casluhim (from whom⁴⁷ the Philistines came), and Caphtorim.

¹⁵Canaan fathered Sidon his firstborn and Heth, ¹⁶and the Jebusites, the Amorites, the Girgashites, ¹⁷the Hivites, the Arkites, the Sinites, ¹⁸the Arvadites, the Zemarites, and the Hamathites. Afterward the clans of the Canaanites dispersed. ¹⁹And the territory of the Canaanites extended from Sidon in the direction of Gerar as far as Gaza, and in the direction of Sodom, Gomorrah, Admah, and Zeboiim, as far as Lasha. ²⁰These are the sons of Ham, by their clans, their languages, their lands, and their nations.

²¹To Shem also, the father of all the children of Eber, the elder brother of Japheth, children were born. ²²The sons of Shem: Elam, Asshur, Arpachshad, Lud, and Aram. ²³The sons of Aram: Uz, Hul, Gether, and Mash. ²⁴Arpachshad fathered Shelah; and Shelah fathered Eber. ²⁵To Eber were born two sons: the name of the one was Peleg,⁴⁸ for in his days the earth was divided, and his brother's name was Joktan. ²⁶Joktan fathered Almodad, Sheleph, Hazarmaveth, Jerah, ²⁷Hadoram, Uzal, Diklah, ²⁸Obal, Abimael, Sheba, ²⁹Ophir, Havilah, and Jobab; all these were the sons of Joktan. ³⁰The territory in which they lived extended from Mesha in the direction of Sephar to the hill country of the east. ³¹These are the sons of Shem, by their clans, their languages, their lands, and their nations.

³²These are the clans of the sons of Noah, according to their genealogies, in their nations, and from these the nations spread abroad on the earth after the flood.

12. Bibliography

- Beitzel, Barry J. *The Moody Atlas of Bible Lands*. The Moody Bible Institute of Chicago. Chicago, Illinois. 1985. (The Table of Nations is on pages 76-79.)
- Brisco, Thomas V. *Holman Bible Atlas*. B&H Publishing Group. Nashville, Tennessee. 1998. (The Table of Nations is on page 36, and is practically identical to Beitzel's, though without the background information.)
- Fruchtenbaum, Arnold G. *Ariel's Bible Commentary*. Ariel Ministries. San Antonio, Texas. 2008. (This book was available free online at libraron.org/book/21802/1, but that link is now dead. It is now only available for purchase.)
- Helgason, Agnar, Axel W. Einarsson, Valdís B. Guðmundsdóttir, Ásgeir Sigurðsson, Ellen D. Gunnarsdóttir, Anuradha Jagadeesan, S. Sunna Ebenesersdóttir, Augustine Kong, and Kári Stefánsson. "The Y-chromosome point mutation rate in humans." *Nature Genetics* 47, pp. 453–457. 2015. www.nature.com/ng/journal/v47/n5/full/ng.3171.html

⁴⁶ **Genesis 10:8** Or *he began to be a mighty man on the earth*

⁴⁷ **Genesis 10:14** Or *from where*

⁴⁸ **Genesis 10:25** *Peleg* means *division*

- Mitchell, T. C. "Sephar." *New Bible Dictionary*. Ed. J. D. Douglas. Eerdmans. Grand Rapids, Michigan. 1962.
- Ross, Hugh. *Navigating Genesis: A Scientist's Journey through Genesis 1–11*. RTB Press. Covina, California. Kindle Edition. 2014.
- Wiseman, D.J. "Peleg." *New Bible Dictionary*. Ed. J. D. Douglas. Eerdmans. Grand Rapids, Michigan. 1962.
- Wiseman, D.J. "Sidon." *New Bible Dictionary*. Ed. J. D. Douglas. Eerdmans. Grand Rapids, Michigan. 1962.